

L-703S 4-Axis Lathe & Turning Center Alignment System

A powerful spindle
alignment tool offering
high accuracy and
fast alignments



- Headstock-Tailstock/Subspindle Alignment
- Spindle-Axis Parallelism to Guideways
- Guideway Straightness, Pitch and Yaw
- 60-70% Faster than Conventional Methods
- Bluetooth Wireless Communication
- .00001 in. (0.25 μ m) Resolution
- .00002 in/ft. (1.6 μ m/m) Angular Resolution
- Small, Compact Fits into Small Lathes
- Lathe10 Win 7/8/10 Software

Lathe and Turning Center Spindle Alignment

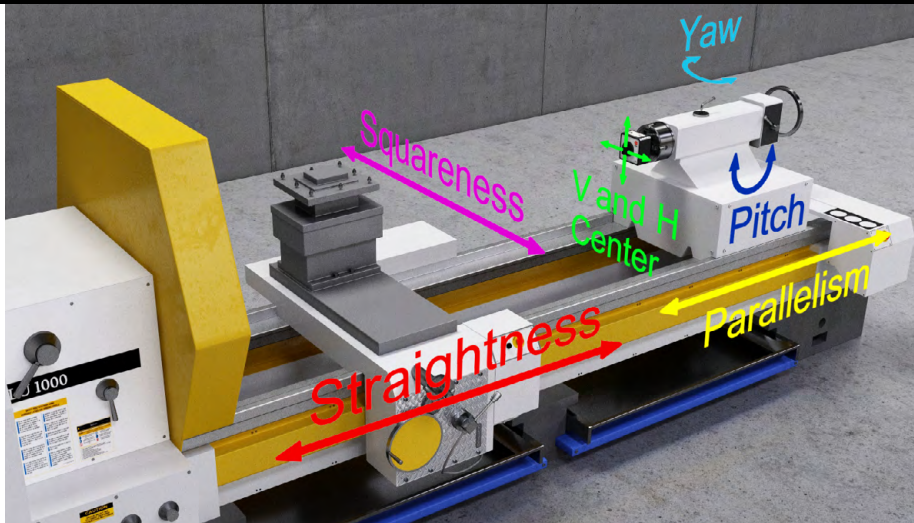

Alignment Parameter Capabilities

- Lathe bed and saddle guideway straightness and flatness
- Pitch and yaw angular axis measurements
- Parallelism of headstock to main bed guideways
- Parallelism of headstock to saddle guideways
- Headstock-to-tailstock 4-axis alignment
- Main spindle to subspindle 4-axis alignment
- Upgrade to L-702SP for cross-slide squareness and multiturn machines

Hamar Laser's 4-axis, L-703S Spindle Alignment System is a powerful alignment tool that offers unparalleled accuracy, easy setup and significant savings in alignment maintenance time. For over 20 years, our spindle alignment lasers have been helping companies reduce tooling costs and scrap rates while increasing their productivity and profitability.

The L-703S features real-time, 4-axis data output, so users can align lathes and turning centers quickly and accurately up to 70% faster than with conventional methods, such as indicators, alignment bars or interferometers. The L-703S has a resolution of to .00001 in. (0.00025 mm) for center and up to .00002 in/ft. (1.6 $\mu\text{m}/\text{m}$) for angular measurements.

Applications include:

- CNC Lathes (slant & straight bed and turret)
- CNC Turning centers
- Cylindrical OD/ID grinders
- Gun-drilling and deep-bore machines
- MultiTurn machining centers

60-70% Faster Alignments Reduces Downtime

A 10-minute setup and real-time data updating, combined with 4-axis measurements, speeds up lathe alignments by 60–70%. It's much faster, more repeatable and easier to use than test bars and indicators.

Aligning a Lathe Quick and Easy

Following our Easy-Guide™, 6-step process in Lathe10, aligning a lathe is quick and easy. After aligning the laser to the spindle's rotation axis, measure the bed for straightness, angular and parallelism errors. If those check out OK, then, without changing the setup, the tailstock, turret or subspindle are checked for alignment to the headstock in 4 axes. That's it!



Lathe10 - Step 1 Dimensions and Tolerances



Lathe10 - Step 3 Alignment Results

Features

- Straightness, pitch and yaw angular measurements of axis guideways.
- Center resolution of .00001 in. (0.25 μm) and angular resolution up to .00002 in/ft. (1.6 $\mu\text{m}/\text{m}$).
- L-703S mounts in the spindle to project its axis of rotation out to 50 ft. (15 m).
- Real-time measurement data in 4 axes
- Bluetooth wireless communication with up to 100 ft. (30 m) of range.
- Lathe10 PC Software corrects mounting errors, calculates shim values and provides an alignment report showing all the alignment parameters of lathe alignment.
- Vertical and horizontal angular adjustments to precisely adjust the laser to spindle's axis of rotation.
- Rechargeable Li-Ion battery with up to 14 hours for both laser and target.
- Compact and rugged - only needs 5.5 in. (140 mm) of space between spindle and subspindle.
- Optional L-103 Beam Translator for high accuracy laser beam centering.
- Simple fixturing for mounting the laser and target.

L-703S Lathe Alignment System Components

Small, Compact and Highly Accurate

Newly designed to be easier to use, smaller to fit into tight spaces and along with extremely high resolution and accuracy to meet today's ever tightening tolerances.



L-703S Laser

The L-703S's laser beam is centered to its mounting stud to within .0003 in. (0.0075 mm). It features pitch and yaw angular adjustments to accurately align the laser to the spindle's rotation axis, which is projected down the lathe so the entire length of the guideways can be easily measured. The operating range is up to 50 feet (15 m).



T-1296 5-Axis Wireless Spindle Target

The T-1296 5-Axis Wireless Spindle High-Resolution Target has a resolution of .00001 in. (0.25 μm) for center. To measure angle, a lens is inserted and produces a resolution of up to .00002 in./ft. (1.6 $\mu\text{m}/\text{m}$) with 6 in. FL lens. It features a 2-axis, super-linear PSD sensor, and Bluetooth communication to transmit its data in real time to Lathe10 Software.



L-103 2-Axis Optical Laser Beam Translator

The optional L-103 2-Axis Optical Laser Beam Translator uses a parallel-sided optic to steer the centering of the laser beam without changing the angle. It's used to precisely put the laser beam on the spindle's rotation axis to remove the small centering error of the L-703S if needed.

Benefits

High Accuracy Measurements Improve Part Quality

The L-703S's super-linear, high-resolution PSD sensors combined with software to correct mounting errors produces a very accurate alignment, less than .0001 in. (0.0025 mm) under good environmental conditions. This extremely high level of accuracy can significantly improve machine performance and reduce scrap rates.

60-70% Faster Alignments Reduces Machine Downtime

Real-time data updating, combined with 4-axis (5-axis with L-702SP) measurements, speeds up lathe alignments by 60-70%. Lathe10 software quickly collects the lathe bed's straightness, pitch and yaw data, analyzes it, and provides a real-time data display to realign the rails if necessary. And, without changing the setup, the headstock and tailstock alignment errors can be quickly fixed, while watching data displays update with each adjustment.

Quick-Alignment Check after Machine Crashes

After a machine crash, all it takes is 10 minutes to get a snapshot of the alignment to see if it needs to be taken offline or not. Or add 10–20 more minutes to get the full alignment picture. Use the Lathe10 Real-Time Move Screen to realign the headstock if it's out.

5-Axis Alignment Target

The L-703S Spindle Alignment System's T-1296 5-Axis Target measures the spindle axis' horizontal and vertical center values and with a quick addition of a lens, it measures the angular values. This combined with Lathe10 Software makes checking and correcting the alignment of the lathe's components much easier and much faster.

Easy Guide™ 6-Step Alignment Procedure

An easy-to-follow, 6-step alignment procedure is built right into Lathe10 software, along with popup instructions, that makes what can be a complicated alignment much simpler and easier to learn. Large color graphical displays allow the alignment data to be seen up to 20 feet (6.5 m) away.

Long-Bed Lathes Done with Ease

With a measuring range of up to 50 ft. (15 m), even the longest lathe bed is easy to measure for parallelism to the spindle axis, eliminating the need for expensive and heavy test bars. Can also be used to set steady-rests and support bushings.

How It Works: Lathes and Turning Centers

One of the most important calibration factors for lathes and turning centers is the alignment of headstock's spindle rotation axis to the machines guideways. The other critical factor is the headstock spindle alignment to the tailstock, sub-spindle, or turret. Conventional methods are cumbersome, time consuming and not very practical on large lathes.

The L-703S simplifies lathe alignment by inserting the laser right into the spindle chuck, and then, using the T-1296 5-Axis Target mounted in the tailstock or subspindle, the laser is aligned to the spindle's rotation axis and projected out to 50 ft (15 m). This becomes the reference from which the guideways, turret and tailstock can be measured and aligned, allowing the entire length of even the largest lathes to be quickly and easily aligned, all from one setup.

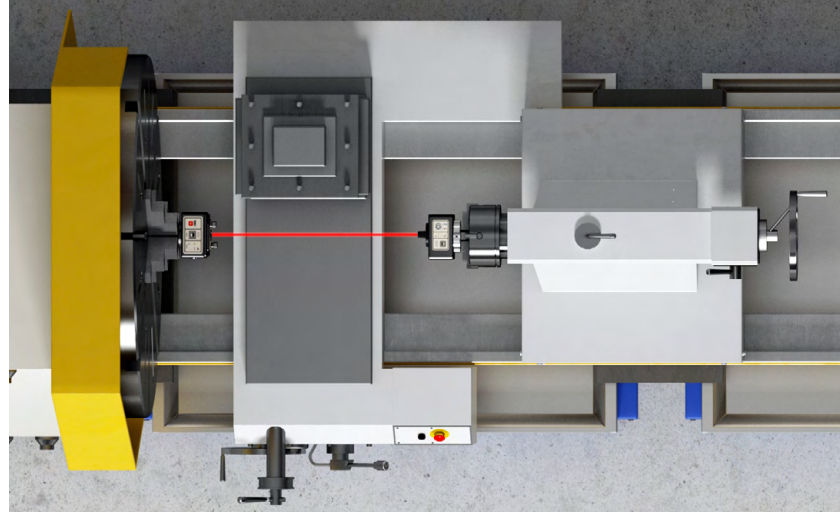

Lathe Alignment Procedure with L-703S



Step 1 - Machine Setup

Insert L-703S into headstock chuck, T-1296 into tailstock and connect it to Lathe10. Enter the project name, number points, dimensions and tolerances.

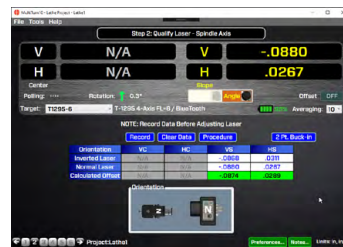

Step 2 - Qualify Laser

With the L-703S/spindle at 180° (or 6:00). Hit Record. Rotate 180 degrees to 0° (or 12:00) and hit Record again. Using the live displays, align laser in angle and center to spindle's rotation axis.



Step 3 - Record Lathe Bed Straightness

Insert T-1296 Target into tailstock or toolholder and bring it close to the laser in the headstock. Hit Record. Move to next point and hit Record again and repeat until all the points have been recorded.

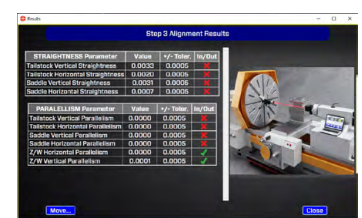

Step 3 - Alignment Results

The vertical and horizontal straightness, spindle AOR parallelism to the main and/or saddle bed ways are displayed and the tolerances are applied. If out of tolerance, the bedway straightness must be fixed and the headstock aligned to the bed before proceeding.



Step 3 - Real-Time Headstock Alignment Screen

To align the headstock to the bed, Lathe9 calculates the shim values and displays a live move screen, which updates the spindle's AOR vertical and horizontal parallelism values as the shims are being added.



Step 4 - Results and Guide-Rail Straightness Graph

Displays a summary of the alignment results and a graph of the guide-rail straightness with several choices to view the graph.



Step 5 - Tailstock/Subspindle Record Screen

Record 6 data points by rotating the spindle/laser and target in the tailstock and Lathe10 will calculate the remaining mounting errors so it can display the alignment results of the tailstock or subspindle to the headstock spindle's AOR.



Step 6 - Tailstock/Subspindle Real-Time Move Screen

A live display for each of the 4 alignment values of the tailstock or subspindle relative to the headstock spindle AOR with shim and spacer calculations to fix the alignment. The alignment values update as shims and spacers are inserted or removed.

Other Applications

Bore Alignment

The L-703B can be packaged with our L-112 Laser Stand, A-512 2-Axis Bore Target, R-1307 Readout and A-514 Self-Centering Bore Adapters to check the alignment of many different kinds of bores, such as engine blocks and compressors. For larger bores, we offer the A-1295LTA Self-Centering Bore Adapter and M-705CLL Customized Bore Tooling, so the T-1296 Target can be used in bore alignment, starting at 6 in. (152 mm) bore diameter and going up to 18 in. (457 mm).

Guideway Straightness for Machine Tool Assembly

Add in our L-702MB Laser Magnetic Base Fixture and L-103 Laser Beam Translator and the L-703S can be used to align guideways (machine rails) on machine tools during assembly. Both the horizontal and vertical axes can be checked at the same time to an accuracy of .0002 in. (0.005 mm) in 10 ft. (3 m). Add in our T-1295-AO-6 Lens and the pitch and yaw can be measured, too, without changing the setup!

MultiTurns and Cross-Slide Squareness

Upgrade to the L-702SP and MultiTurn10, and the rest of the system can be used to measure squareness of lathe cross-slides, the straightness of multiturn machining axes and the squareness between them.

Twin-Barrel Extruders

Using a combination of L-703B Laser and targets from our L-705 Extruder Bore Alignment System, Hamar Laser has put together a package that works exceptionally well for twin-barrel extruders. It uses the L-703B Bore Laser, the A-703T Spline-Shaft Fixture and the A-510 2-Axis Self-Centering Target to align twin-barrel extruders to within .001 in. (0.025 mm) in 25 ft. (7.6 m).

If the twin-barrel is under construction, the system can be used to align each section of the barrel. If the extruder is already installed, the target can be inserted up to 25 ft. (7.6 m) into the barrel and positioned over adjustment points. The readout displays the misalignment dynamically, or Bore9 records and plots straightness.

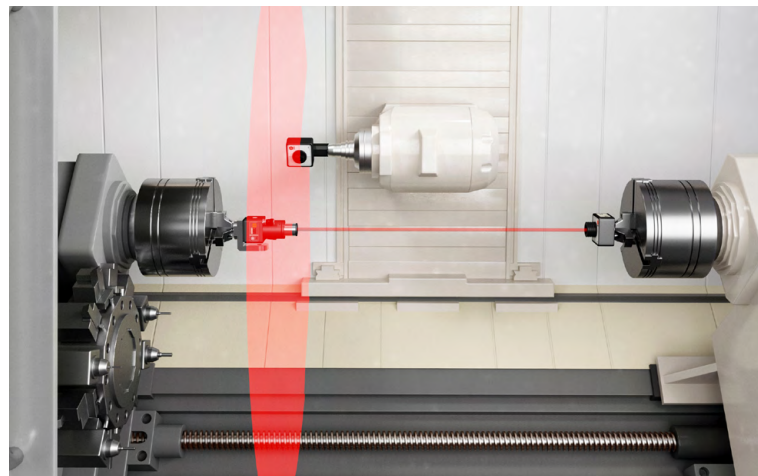
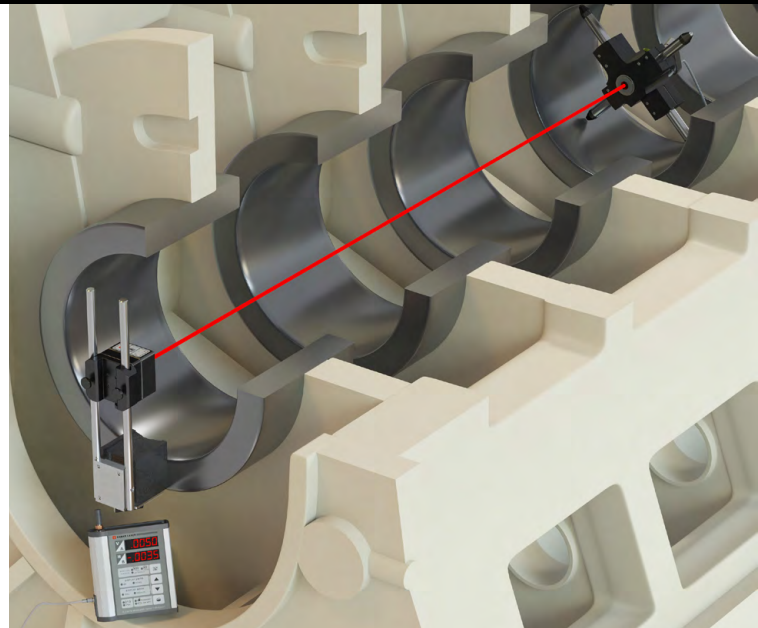

L-703S Spindle Alignment Laser

Size	(See line drawings)
Weight	1.2 lbs. (0.5 kilograms)
Battery	3.6v LiPo rechargeable
Battery Life	11+ hours continuous use
Laser Concentricity to Mounting Stud	<.0005 (0.012 mm) - no adjustment
Angular Adj. Resolution	.00002 in/ft (1.6 µm/m)
Angular Adj. Range	±0.36° (±.075 in/ft. or ± 6.26 mm/m)
Operating Distance	up to 50 ft. (15 m) with standard laser. Longer distances available with L-703LD
Laser Type	Laser < 0.9 mW, BRH Class II
Wavelength	650 nanometers
Materials	Plastic housing, aluminum frame and 440 SS steel mounting stud with hardness of RC 54-60.
Laser Beam Modes	Continuous and double-blink mode (for ambient light correction). Supports T-1295/T-1296 5-Axis Targets plus the T-261 (with R-358).

L-103 Optical Beam Translator

X-Y Center Adj/ Resolution	.0001 in. (0.0025 mm)
X-Y Center Adj. Range	±.043 in. (±1.09 mm)

L-703S Spindle Alignment Laser

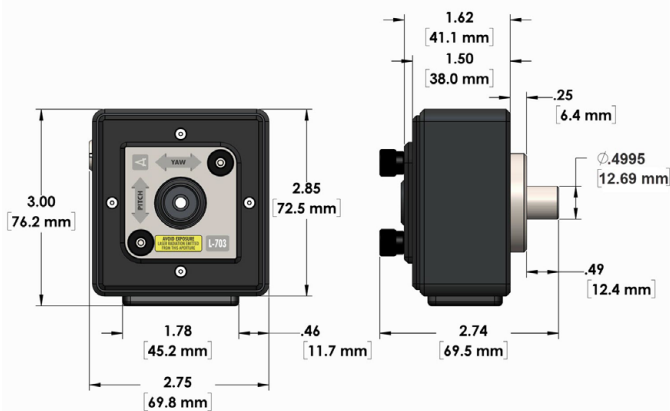

L-103 Optical Beam Translator Dimensions

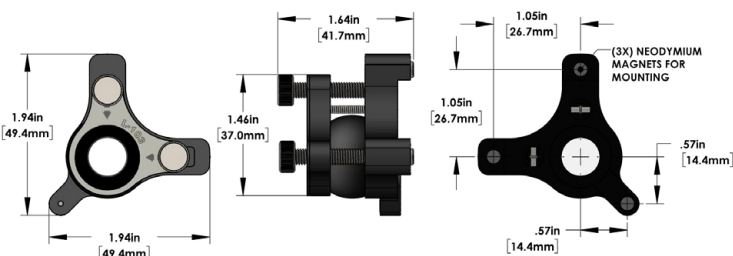

T-1296 5-Axis Target

Dimensions	3.23 x 3.23 x 1.8 in. (82 x 82 x 45 mm) – see more details below
Sensor	10 x 10 mm 2-Axis, Super-Linear PSD
PSD Resolution	Center Mode: .00001 in. (0.00025 mm) – 2 axis (X/Y) Scanning Mode (w/L-702SP): .00001 in. (0.00025 mm) – 1 axis
Angular Lens Resolution	T-1296-AO-3 3 in. (75 mm) FL: .00004 in/ft (3.2 µm/m) T-1296-AO-6 6 in. (152 mm) FL: .00002 in/ft (1.6 µm/m)
PSD Accuracy	Center: <0.25% of change in measurement Angular: <0.10% of change in measurement
PSD Concentricity to Stud Mount	<.0003 (0.008 mm) - remaining errors removed by MultiTurn10 NORMIN procedure.
Measuring Range	Center: ±.12 in. (±3 mm) Angle 3 in. (75 mm) Lens: ± 2.5° (.51 in/ft or 43 mm/m) Angle 6 in. (152 mm) Lens: ± 1.3° (.26 in/ft or 21 mm/m)
Rotation Sensor Resolution	0.1 deg. Accuracy: ±1 deg.
Wireless Range	Bluetooth Class 1 with 100 ft. (30 m) communication range
Material	Plastic cover and aluminum frame
Mounting Stud	.4995 in. (12.687 mm) diameter. 440C stainless steel, RC54-58 hardness. Can be customized.
Weight	T-1296 Target: 15 oz. (452 g) T-1296 Lens: 2 oz. (57 g)
Battery	Lithium polymer rechargeable with 14 hours battery life. Target can be used while plugged in.
Ambient Light Protection	Blinking laser capability removes ambient light effect on accuracy. The light shield is for using target in Center Mode to reduce ambient light effects in bright light conditions.
Measurement Modes	2-Axis Center, 2-Axis Angular - supports L-702, L-702SP and L-703 beam lasers. 1-Axis Scanning - supports L-702SP, L-730/L-740 Series, and L-750 Scanning lasers for measuring flatness of axes, surfaces and guideways.

T-1296 5-Axis Target Dimensions



Hamar Laser Instruments, Inc.
5 Ye Olde Road Danbury, CT 06810
Fax: 203.730.4611 Int'l: +1.203.730.4600
sales@hamarlasers.com www.hamarlasers.com

