



# *L-706 Operations Manual*

## *Turbine Alignment*

*January 2025*

*Rev F2*



HAMAR LASER INSTRUMENTS, INC.  
[www.hamarlaser.com](http://www.hamarlaser.com)

Five Ye Olde Road, Danbury, CT 06810  
Phone: (800) 826-6185 Fax: (203) 730-4611

## **WARRANTY**

Hamar Laser Instruments, Inc. warrants each instrument and other articles of equipment manufactured by it to be free from defects in materials and workmanship under normal use and service. Its obligations under this warranty are limited to making good at its factory any instrument and other article of equipment, which shall, within one year after shipment of each instrument and other article of equipment to the original purchaser, be returned intact to Hamar with transportation prepaid, and which Hamar's examination shall disclose to Hamar's satisfaction to have been thus defective. Other than this express warranty, Hamar neither assumes, nor authorizes any other persons to assume for it, any other liability or obligation in connection with the sale of its products.

This warranty is not applicable to instruments or other articles of equipment manufactured by other companies and is limited by a warranty extending for less than one year. In such an event, the more limited warranty applies to said instrument or article of equipment.

This warranty shall not apply to any instrument or other article of equipment which shall have been repaired or altered outside the Hamar factory, nor which has been subject to misuse, negligence, or use not in accord with instructions furnished by the manufacturer.

The software described in this manual is furnished under a license agreement and may be used or copied only in accordance with the terms of the agreement. It is against the law to copy the software on any medium for any purpose other than the purchaser's personal use.

The information in this manual is subject to change without notice. No part of this manual may be reproduced by any means, electronic or mechanical, without written permission from Hamar Laser Instruments, Inc.

**© Copyright Hamar Laser Instruments, Incorporated, 2025  
5 Ye Olde Road, Danbury, Connecticut 06810**

# Table of Contents

---

---

Turbine Alignment Hardware .....	1
Important Note on Calibration and Laser Modes .....	2
The L-706 Laser .....	3
L-706 Features and Setup .....	3
Pulse/Continuous Modes (L-706 and L-706 Lasers) .....	4
Adjusting the L-706 Laser .....	4
Attaching the Battery Pack .....	5
Replacing the Batteries .....	5
A-502A 2-Axis Target Fixture .....	6
A-502L 2-Axis Laser Fixture .....	6
T-218T 2-Axis Turbine Target.....	7
A-1511 Wand Bore Fixture.....	7
A-1519-2.4XBE-2X 2-Axis Wireless Target.....	8
The Model R-1307-2.4XBE Readout.....	9
R-1307 Control Panel .....	10
Configuring the R-1307 for a Cabled (Local) Target .....	11
R-1308 Auxiliary Target Readout - Overview .....	12
Mounting the R-1308 .....	12
Mounting the R-1308 on the A-1511 Wand Bore Fixture.....	13
Using the R-1308 .....	13
Zeroing the Display.....	13
Using the Display Mode Button .....	14
Performing a Turbine Alignment.....	15
Preparing for an Alignment.....	15
Hardware Preparation .....	15
Installing the “Pac Man” Magnets.....	16
Installing the Pack-Man Magnets with Angle Iron.....	18
Magnet Setup for A-502L Laser End.....	19
Pac-Man Magnet Setup for A-502A (Target End) .....	21
How to use the A-501(A) Bore Sweep Unit .....	22
How to Rough Align the A-502L .....	27
Final L-706 Laser Buckin to T-218T Target .....	30
How to Take Data with the T-218T/A-502A/A-501A .....	31
How to Take Data with A-1511 Wand Bore Fixture.....	33
Using the R-1308 Readout Display-Mode Button for the A-1511 .....	35
Data-Taking Procedure with the A-1511/A-1519-2X-2.4XBE & R-1308 Readout.....	36
Calculating the Bore Misalignment .....	39
Measuring Bores Using the A-1511/A-1519-2.4XBE-2X & R-1307 Readout .....	40
Full Bore Accessories. ....	44
Appendix A – The NORMIN Method (Bore and Spindle).....	48
Appendix B – Configuring the R-1307-2.4XBE Readout .....	50
Appendix C – Care and Cleaning of Target Optics .....	53

# Turbine Alignment Hardware

---

L-706 Bore Alignment Laser is designed to perform alignment of gas and steam turbine bores. The system uses a laser, reference target, measuring target, micrometer sweep device, and fixtures to hold the laser and targets. Since the laser beam is concentric to the OD of the L-706/706 housing to within .0005 in. (0.013 mm), it can serve as one reference target, saving a lot of time during setup.

On most turbine alignments, the rotor bearing bores are used as the references. This means that fixtures that hold the laser and reference target must be placed precisely in these bores to the bore-center set points determined by the manufacturer of the turbine.

The fixtures are hung in the bores using angle iron and special magnetic bases. Depending upon the size of the bore, either the A-501 Large-Bore Sweep Unit, or the A-501A Small-Bore Sweep Unit is used to position the fixture so that the fixture's center is exactly on the reference points provided. The sweep unit is essentially an inside micrometer that allows the fixture to be placed to any points desired (for example, .000 in. left, .009 in. right and -.010 in. bottom).

Once both fixtures are swept in, the L-706 Laser is placed in one reference fixture and a T-218T Target is placed in the opposite reference fixture. Since both the L-706 Laser and T-218T are manufactured so that the laser beam and PSD are concentric (centered to) to the housing's OD, when they are inserted into their respective fixtures, the laser and PSD are centered to the reference bores.

All that is needed now is to adjust the angle of the laser beam, using the two micrometers on the back of the L-706. These micrometers are adjusted until the reference target reads zero, both vertically and horizontally. The laser is now set up and ready for measurements.

For measuring an individual component, such as a diaphragm, there are two target choices. The first is the T-218T Turbine Target. The T-218T works much the same as the reference targets. The A-502A Target Fixture is swept into the center of the bore using the A-501(A) sweep unit, and then the target is placed in the fixture and the reading is taken. A positive vertical reading means the diaphragm is higher than the reference bores. A positive horizontal reading means the diaphragm is to the right of the reference bores. Since the data is live, the diaphragm can be adjusted until the reading is zero (or to an offset determined by the engineers).

The second measuring target that can be used is the A-1519-2.4XBE Target and A-1511 Wand Bore Fixture. Instead of using a fixture to "hang" a target in the center of the bore, the A-1511 uses fixed-length legs that are approximately equal to the radius of the bore to support it. Two legs are used, each 90 degrees from the other. One leg has a measuring tip on it and the other is used for support. The A-1511 is then swept through the arc in a similar way as taking tight-wire readings with an inside micrometer. The A-1511 has replaceable legs and can be used on bores with a radius of 10 to 96 in. (254 mm to 2.44 m).

## Note on Data Repeatability

Both the A-1511 and T-218T measuring targets are very repeatable. However, in our experience, the A-1511 is much faster at taking the measurements. To get the best repeatability, some mechanism should be employed to ensure that each point on the diaphragm or other component are marked and the measuring tip is placed exactly on the same point. Given that the surfaces inside a turbine are usually pitted and rough, a radius tip should be used. For new turbine installations, repeatability of .001 in. (0.025 mm) or better is easily achievable. However, for older turbines, it becomes increasingly more difficult to hold .001 in. repeatability because of the high level of pitting and corrosion.

### Recommended System Configuration

L-706 Long Distance Bore Laser  
R-1307-2.4XBE Target Readout  
T-218T 2-Axis Turbine Target  
A-501A Turbine Small Bore Sweep Unit  
A-502A Turbine Reference Target Bracket  
A-502L Laser Support Bracket  
A-1511 Wand Bore Fixture  
A-1519-2.4XBE-2X Single-Axis 2.4GHz Wireless Scan Target  
R-1308 Single-Axis Readout  
A-816 Shipping Case

### Optional Accessories

A-501A Turbine Bore Sweep Unit

# Important Note on Calibration and Laser Modes

Each 2-axis target needs to be calibrated to an R-1307 Readout. If there are 2 targets, then there will be 2 calibration records in the R-1307. The correct calibration record needs to be matched to the target ID when using the equipment.

When configuring the R-1307 Readout, it is critical to match the target ID with the target identifier at the end of the serial number of the target. For example, if the target identifier for the target serial number label is “-2”, then the R-1307 must also be set to the TGT.02. If the target and readout are not matched, a centering error of up to .002 in. (0.05 mm) can occur.

## Laser Modes

In addition, the laser switch setting (CONT. or Fixed vs. PULSE) must also agree with the R-1307 Readout setting. For CONTinuous (Fixed) Mode, set the R-1307 to F10.10 and for Pulsed Mode, set the R-1307 to P10.10.

For example, the 2 options for R-1307 #2 are:

1.  $t6t=02 F. 10. 10$  or
2.  $t6t=02 P. 10. 10$

For complete information on matching the target to the readout, see *Configuring the R-1307 Readouts for a Cabled (Local) Target* on Page 10.



## The L-706 Laser

The L-706 Laser has been designed with a .750 in. (19.05 mm) mounting stud and flat face with magnets to hold it flush to fixturing. Since the laser beam is concentric to the OD to within .0005 in. (0.01 mm), a simple flat face and .750 in. (19.05 mm) hole on center is all that is needed to hold the laser.

### L-706 Features and Setup

The L-706 has a range of 100 ft. (30 m), and under good environmental conditions, it is accurate to .003 in. (0.075 mm) over the whole range.

The L-706 provides a straight reference line to which any bore can be aligned and measured. The laser mounts in an adapter or laser fixture. The laser projects a beam through the adapter and down through the inside of a bore or barrel toward any of Hamar's bore targets, which are mounted in the opposite end of the bore.

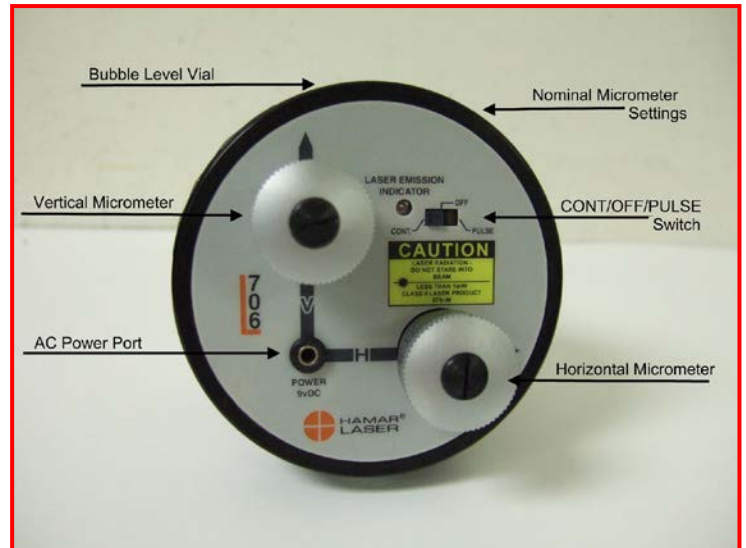

Figure 1 – L-706 Laser

The following describes the operational features of the L-706 Laser. These features include bubble level vial orientation, micrometer values and settings, ON/OFF switches and the external battery pack.

- **The ON/OFF slide switch** has a lighted LED to indicate that power is ON.
- **The Pulse/Continuous switch** selects the laser mode compatible with the readout/interface being used (see Page 4 for more information about Pulse/Continuous modes and the readouts used for each mode).
- **Battery Pack connector** accepts a slip-fit probe with a flexible cord.
- **Bubble-level vials** on the laser mounting flange are used for rotational accuracy. When the bubbles in the level vial are centered horizontally, all micrometer adjustments (controlling laser beam angle) will shift the laser beam vertically or horizontally with reference to the bore/target axis. If the bubbles are not centered, any micrometer adjustment to one laser axis will change the laser beam position in both axes. The levels also provide fixture mounting repeatability (assuming the laser is hard mounted to the fixture).
- **Micrometer controls** are provided for the adjustment of the angle at which the laser beam emerges from the precision ground, mutually concentric steel laser housing. Each laser has a NOMINAL setting for both the V-Vertical and the H-Horizontal micrometer controls. The nominal settings are determined at the factory and correlate to values for the laser beam when it is perpendicular to both the 2 in. and 4 in. mounting faces. When the bubble in one of the level vials is centered, a nominal setting of each micrometer squares the laser beam to that specific axis. For example, if the nominal vertical setting is .120, then setting the micrometer to .120 sets the laser beam square to the vertical axis. When a laser is mounted in the gearbox or bore adapter, vertical and horizontal micrometers should be *set in the nominal positions* to facilitate the alignment and measurement process.

## Pulse/Continuous Modes (L-706 and L-706 Lasers)

The L-706 and L-706 Lasers are equipped with a PULSE/CONTInuous switch (see **Figure 1**), which manually switches the laser beam between *Pulsed* and *Fixed Beam Modes*. *Pulse Mode* is the preferred mode and automatically removes the effects of excess (ambient) background light for the R-1307 readouts, providing a more accurate reading. The R-1307 Readout (excluding R-1307B & R-1307BC) is capable of supporting both Pulse Mode and Continuous Mode, as well as storing up to 9 different target calibration factors for multiple target users. These capabilities must be specified when ordering a system.

The chart below indicates the operational modes for Readouts/Computer Interfaces that operate with the L-706/L-706 Lasers:

Mode	Readouts	Computer Interfaces
Pulse	R-1307B-2.4ZB, R-1307BC, R-1307C, R-1307-900/2.4, R-1307-2.4XBE, R-1307+R	A-910-900/2.4 (when used with R-1307-900 or R-1307-2.4) A-910-2.4ZB
CONTInuous	R-307, R-307V	R-358

### Notes:

1. The T-261A and T-266 Targets when used with the R-358 do not support the Pulsed-Beam Mode and the system purchased is factory-configured to operate in CONTInuous mode when using these targets.
2. When using the L-700 Laser with the R-1307 and a 2-Axis Target, the system is factory-configured to operate in CONTInuous mode.

## Adjusting the L-706 Laser

The L-706 Laser beam is factory adjusted to be concentric to the mounting diameters (2.25 in. or 57.15 mm and .75 in. or 19.05 mm) within .0005 in (0.0127 mm). With the adjusting micrometers set at the nominal position, (see the **Nominal Settings** label on the outer flange), the laser beam is perpendicular to the front mounting surface and parallel to the mounting diameters within  $\pm .0003$  in/ft.

In a typical bore measuring application, the L-706 Laser is mounted concentric to one end of the bore by means of a fixture ring or plate. Because fixtures are seldom perfect, the laser beam requires angular adjustment to make it concentric to the bore.

The circular level vial on the laser mounting flange is used to orient the vertical and horizontal axes of the L-706 Laser to the V and H axes of the target's PSD sensor. When the bubble in the level vial is centered, all micrometer adjustments (controlling laser beam angle) will shift the laser beam vertically or horizontally relative to the target's PSD axes. If the circular level bubble is *not* centered, any micrometer adjustment to one laser axis *will make the laser beam position appear to change in both axes*. The level vial also provides fixture mounting repeatability (assuming the laser is hard mounted to the fixture).

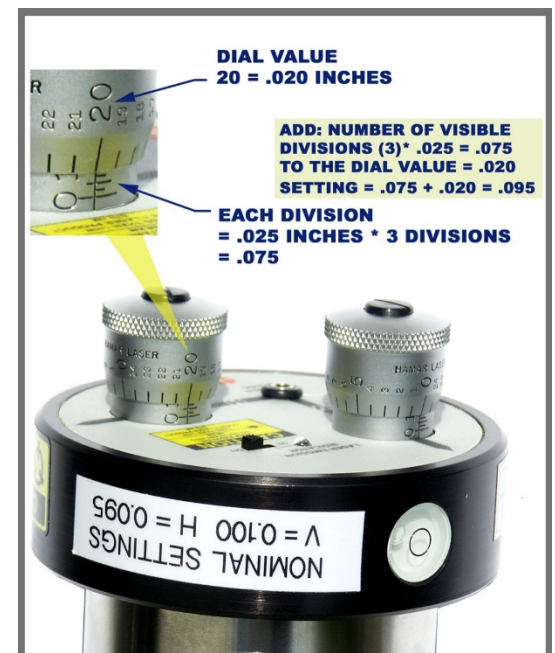

Figure 2 - Adjusting L-706 Micrometers

## Attaching the Battery Pack

The L-706 Laser battery pack is a stand-alone unit that attaches magnetically to an extruder gearbox. The battery pack has a detachable cord with a probe at each end. One probe attaches directly to a jack on the battery pack and the other probe is inserted in the control panel of the L-706 Laser.

### 1. Turn off the main power switch.

The main power switch *must* be off before attaching the battery pack.

### 2. Insert the probe into the battery power input jack.

The jack is located on the end panel of the battery pack. Insert the plug gently until it snaps into place.

## Replacing the Batteries

The battery pack uses two 9-volt batteries. The batteries are housed in a two-part case which is held together by flathead screws. Hamar Laser recommends using alkaline or nickel-cadmium (NiCad) cells for best performance.

### 1. Unplug the battery pack from the laser.

Pull the probe out of the laser control panel and gently set aside.

### 2. Unscrew the cover of the pack.

Locate and loosen the two captive flathead screws and remove the cover.

### 3. Replace the two batteries.

Remove the old batteries and replace them with new 9-volt cells, being careful to orient them with the *negative terminal out (or up)*.

### 4. Re-attach the cover.

Put the cover back on and secure it to the battery pack with the screws.

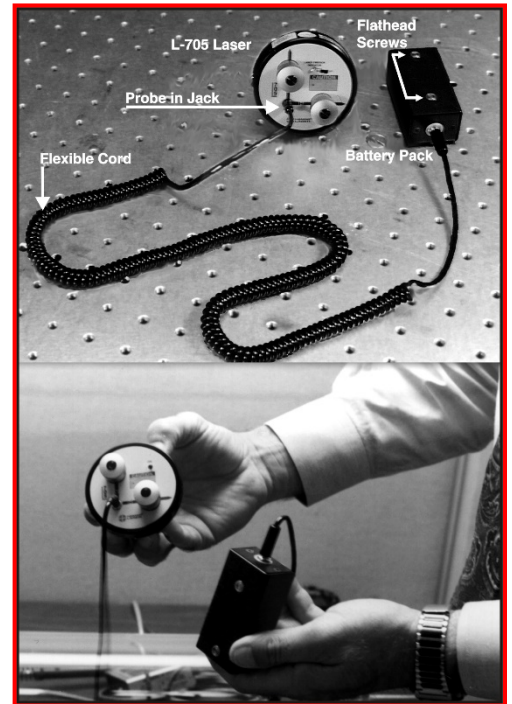

Figure 4 - Attaching the Battery Pack



## A-502A 2-Axis Target Fixture

The A-502A 2-Axis Target Fixture is designed to hold the T-218T 2-Axis Target and the A-501(A) Sweep Fixture onto 2-in. (50.4 mm) angle iron. It has X and Y axis adjustments with push-pull screws to center the fixture to a bore using the A-501(A) Sweep Fixture as a gauge for centering. The T-218T has the same  $\text{Ø} 2.2495$  in. ( $\text{Ø} 57.137$  mm) mounting surface as the A-501(A) and the PSD sensor is concentric to this mounting surface to within  $.0005$  in. (0.013 mm). So when the A-501(A) is used to “sweep in” the A-502A to the bore center and the T-218T is placed in the A-502, it is centered to the bore.

It is best to start off alignments by centering the adjustment range of the fixture in the center of the range – see Figure xx, page 14 for more details.

## A-502L 2-Axis Laser Fixture

The A-502L 2-Axis Laser Fixture is designed to hold the L-706 Bore Laser and the A-501(A) Sweep Fixture onto two sets of 2-in. (50.4 mm) angle iron. It has X and Y axis adjustments with push-pull screws to center the fixture to a bore using the A-501(A) Sweep Fixture as a gauge for centering. The L-706 Laser has the same  $\text{Ø} 2.2495$  in. ( $\text{Ø} 57.137$  mm) mounting surface as the A-501 and the laser beam is concentric to this mounting surface to within  $.0005$  in. (0.013 mm). So when the L-706 is placed in the A-502L, it is centered to the bore and all that is needed to complete the laser setup is tilting the laser beam to the reference target.

It is best to start off alignments by centering the adjustment range of the fixture in the center of the range – see Figure 13, for more details.

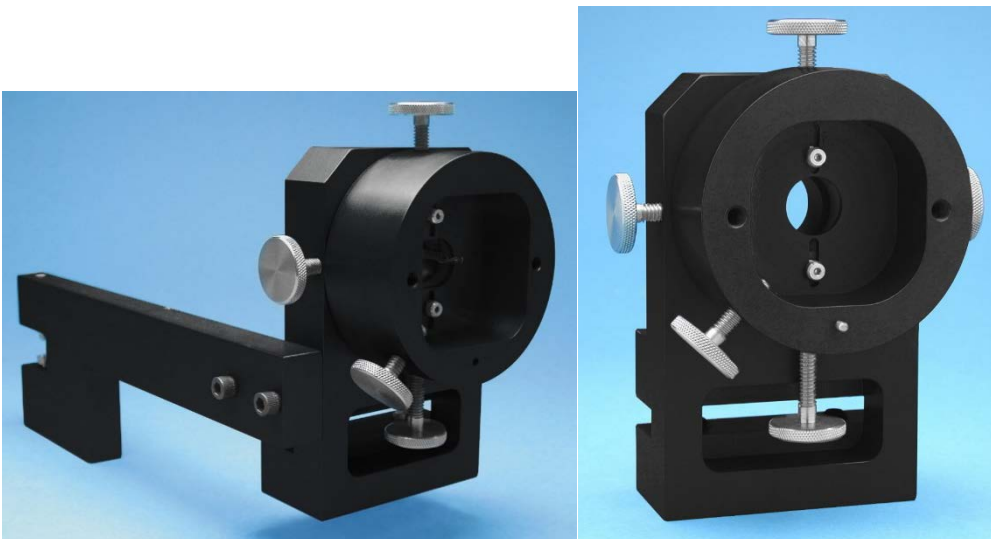

Figure 5 - A-502L Laser Fixture (left) and A-502A Target Fixture (right)

## T-218T 2-Axis Turbine Target

The T-218T Turbine Target is a 2-axis target designed to measure bore alignments in steam turbines. The target sensor (PSD) is centered to the  $\text{\O}2.2495$  in. ( $\text{\O} 57.137$  mm) mounting surface to  $< .0005$  in. (0.013 mm). It also features a prism assembly that flips out of the way to allow the laser to pass through the target to a second target.

The T-218T is positioned to the center of a half-bore by using the A-502A Target fixture, angle iron and the “Pac-Man” magnets to hold it in place. The A-502A fixture is then “swept in” (indicated-in) to the center of the bore using the A-501(A) sweep unit. Then, the T-218T Target is placed in the A-502A fixture, and the reading is taken. A positive vertical reading means the diaphragm is higher than the reference bores. A positive horizontal reading means the diaphragm is to the right of the reference bores. Since the data is live, the diaphragm can be adjusted until the reading is zero (or to an offset determined by the engineers).



Figure 6 – T-218 Target

## A-1511 Wand Bore Fixture

The A-1511 Wand Bore Fixture speeds data-taking for steam turbine bores with diameters from 10 in. to 96 in. (254 mm to 2.44 m). It provides high levels of repeatability for faster measurement-taking to help reduce overhaul alignment times by up to 50 percent. The fixture uses two fixed-length legs approximately equal to the radius of the bore, one leg with a measuring tip and one for support.



Figure 7 - A-1511 Wand Bore Fixture

## A-1519-2.4XBE-2X 2-Axis Wireless Target

The A-1519-2.4XBE-2X 2-Axis Wireless Target provides wireless communication with a measuring range of  $\pm.55$  in. ( $\pm 14$  mm) in the vertical axis and  $\pm.13$  in. ( $\pm 5$  mm) in the horizontal axis. It has a wireless operating range of 100 ft. (30.5 m) from laser to target using XBEE® 2.4GHz radios.

The A-1519-2.4XBE-2X features a resolution of .00002 in. (0.0005 mm), a fully linearized, position-sensitive detector with automatic background-light correction, automatic on/off operation (laser turns it on), and an on-target indicator.

The target is linearized to within  $\pm.00015$  in. ( $\pm 0.0038$  mm) over the useful range of the target. It is used with the A-1511 Wand Bore Fixture for measuring half-bore alignment, typically in steam turbine applications. It features an electronic zero button for easy zeroing when used in turbine applications.

It can be converted to single-axis Scan Mode to be used with our L-730/L-740 Scanning Laser to measure the flatness of any surfaces, such as split joints.

### Applications

- Bore alignment of turbine half-bores, flatness, levelness, straightness, squareness and parallelism of machine tools, and roll alignment applications. Primarily for use with the L-706 Bore Laser, but it can also be used with the L-730/740 series of lasers.

### Features

- Wireless infrared communication with a range of up to 100 ft. (30.5 m) with a direct line of sight.
- The A-1519-2.4ZBE-2X has a resolution of .00002 in. (0.0005 mm). The A-1520 has a resolution of .00001 in. (0.00025 mm).
- The A-1519 is linearized to within  $\pm.00015$  in. ( $\pm 0.0038$  mm).
- Measuring range of  $\pm.55$  in. ( $\pm 14$  mm) in the vertical axis and  $\pm.13$  in. ( $\pm 5$  mm) in the horizontal axis.
- Automatic background-light correction for added accuracy.
- Can easily be converted to Scan Mode for use with the L-730/740 scanning lasers.
- Automatic on/off operation with no switches, wires or connections with convenient Zero Button
- Flashing target indicators provide immediate "off-target" status.
- Powered by a rechargeable lithium-ion battery and comes with AC adapter/charger with up to 11 hours of battery life.
- Low battery and charging indicators show when charging is complete.



**Figure 8**—A-1519-2.4ZB Single-Axis Wireless Target

## The Model R-1307-2.4XBE Readout

The Model R-1307 Readout supports both wireless A-1519-2.4XBE-2X Targets or cabled (local) targets. It is available with a radio frequency 2.4 GHz ISM band. The R-1307 can be used as the primary readout or as an additional readout to copy position data captured by another R-1307.

- Supports both wireless targets (A-1519-2.4XBE-2X) or cabled (local) targets (A-220, A-221, A-510, A-512, T-212, T-218, T-219 T-271)
- Can be configured to support both pulsed-beam and continuous laser modes
- Radio frequency 2.4 GHz ISM band
- Can also be used as an additional readout to receive data alignment data transmitted from another



Figure 9 - R-1307 Readout

## R-1307 Control Panel

Figure 7x shows the features of the R-1307 “Full Version” Control Panel.

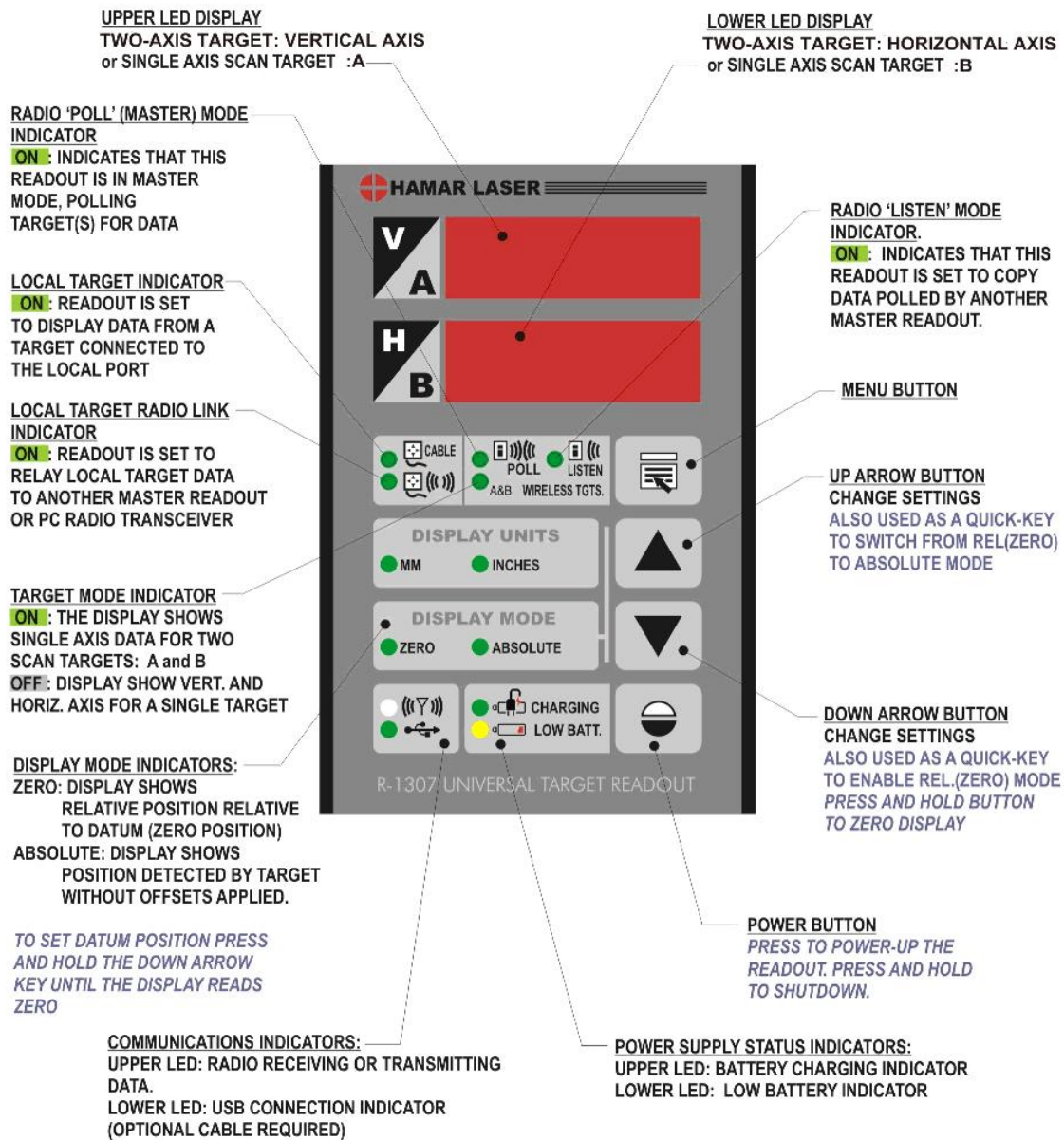

Figure 10 - R-1307 “Full Version” Readout Control Panel Features

## Configuring the R-1307 for a Cabled (Local) Target

**Note:** Shut off power to the readout before connecting or disconnecting a target from the local port.

1. **Connect the cabled target to the local port of the readout.**
2. **Press and hold the MENU button for approximately 2 seconds to enter configuration mode.**
3. **Set the Measurement Units**

Press the MENU button until the upper display shows  $UNITS$ . Use the UP and DOWN arrow keys to select either  $INCH$  for inches or  $MILL$  for millimeters.

4. **Set the Averaging Level**

Press the MENU button until the upper display shows  $AVERG$ . Use the UP and DOWN arrow keys to set the number of averages. Adjust this value as required to suit the application. The default for this application should be at least 8. For long-distance applications, use 16 or 32.

5. **Set the Readout Function to Cabled (Local) Target**

Press the MENU button until the upper display shows  $FUNCTION$ . Use the UP and DOWN arrow keys to select  $FUNCTION: LOCAL$ .

6. **Select the PSD descriptor applicable to your target**

Press the MENU button until the upper display shows  $PSD=nn$ , where  $nn$  designates the target number. Each R-1307 has three target descriptors:

- $PSD=0$  (for HLI use only. Do not use)
- $PSD=nn$ , P.10.10 (pulsed beam mode) – this is the preferred mode.
- $PSD=nn$ , F.10.10 (fixed beam mode)

$nn$ = R-1037 Readout number and matching target number (see page 1 for an example).

Press the UP or DOWN arrow to select the correct target number and to change the second window. For example,  $PSD=02 F. 10. 10$  or  $PSD=02 P. 10. 10$  for R-1307 #2

**WARNING:** The R-1307 can store up to 9 target calibration factors. Therefore, 2 or more targets can be used with one R-1307 Readout by specifying the target number in the R-1307 menu. The R-1307 then uses the calibration factors for the target number selected. If, however, a target number is entered in the R-1307 menu that does not correspond to the actual target in use, calibration factors will be incorrect.

7. **To exit configuration mode, press and hold the MENU button for approximately 3 seconds until the display returns to normal mode or wait for 10 seconds and it will do it automatically.**

# R-1308 Auxiliary Target Readout - Overview

The R-1308 Auxiliary Target Readout is an accessory for the A-1519 and A-1520 Type II A-1519-2.4XBE-2Xs. This single-axis, lightweight readout attaches directly to the post of the magnetic target base, or the A-1511 Wand Bore Fixture. It connects to the auxiliary port on the side of the target, providing the target data instead of using the R-1307.

**Note:** This unit operates with A-1519-2.4XBE-2X firmware version 8.021 or later. Units shipped prior to July 15, 2007, may require a firmware upgrade, available from Hamar Laser Instruments.

## Target Features

- Bright LED display with up to 4 decimal places of resolution for easy target readings.
- No batteries, external power supply or charger is required. The unit is powered directly by a connection to the A-1519-2.4XBE-2X and draws a minimal amount of power directly from the A-1519-2.4XBE-2X battery. At the normal brightness setting, the target display draws less than 100 mW.
- User-selectable display allows the target position to be viewed in either inches or millimeters and in Relative (Zero) or Absolute modes.

The picture at the right shows the A-1519-2.4XBE-2X mounted on a standard 5/8 in (15.75 mm) diameter post, with the R-1308 mounted directly beneath the target. The numerical indicators are as follows:

- (1) **Locking nut**
- (2) **A-1519-2.4XBE-2X Auxiliary Port** (supplies power to the R-1308 Target)
- (3) **Display Units**
- (4) **Display Resolution**
- (5) **Zero Mode** (Relative/Absolute)
- (6) **Display Mode** used for turbine alignment to display an approximation of the H axis value when the A-1519 is used in 2-axis Mode. Also used to change the brightness of the display.



## Mounting the R-1308

1. Wait until the A-1519-2.4XBE-2X Target has turned off (about 20 secs).
2. Slide the R-1308 mount on to the target post until it is 1 in (25 mm) or less below the base of the target. The R-1308 can be mounted perpendicular to the target post, as shown, or parallel to the target post for vertical plane applications.
3. Tighten the locking nut.
4. Connect the R-1308 cable to the A-1519-2.4XBE-2X Auxiliary Port. *Do not force the connection.* The arrow on the plug should face toward the back of the target.

## Mounting the R-1308 on the A-1511 Wand Bore Fixture

To use the R-1308 with the A-1511 Wand Bore Fixture, mount a target post to the top of the fixture as shown. Then, slide the R-1308 onto the post and position it so it can be easily seen. Attach the connector to the side of the A-1519-2.4XBE-2X Target.



Figure 11 - R-1308 Mounted on A-1511 Wand Bore Fixture

## Using the R-1308

1. Turn on the power to the A-1519-2.4XBE-2X. The R-1308 displays *-HLI* - while it initializes. *Do not proceed until a numerical reading is displayed.*
2. Set the Display Units by pressing the DISPLAY UNITS button to toggle between inches and millimeters. The corresponding LED on the front panel lights.
3. Set the Display Resolution (the desired number of decimal places) by pressing the DISPLAY RES button.

## Zeroing the Display

1. To enable Relative Mode, *press and hold* the ABS/REL button until the display reads zero. Release the button. The last position reading is memorized as an offset that is subtracted from all subsequent position readings. The REL LED lights when the display shows a zero offset applied.
2. Press the ABS/REL button quickly to toggle between Relative and Absolute modes.

**Note:** The best way to zero the display without disturbing the position measurement is to place your index finger directly behind the ABS/REL button and then push the button with your thumb, as if you are pinching the right side of the unit.





## Using the Display Mode Button

The Display Mode button is used when using the A-1519 target in 2-axis mode (see pages 24-24 of the A-1519 Manual) to show an approximation of the H axis values. By pressing the Display Mode button, the readout is switched from showing the V-axis data (actual numbers) to showing the H-axis data represented by lines. Each line equals the values shown below. If the lines appear to the *right* of zero, this means the target is to the *right* of the laser beam and vice versa.

The lines equal a range of distances from the center of the target in the H axis as shown below:

□ = zero

I = .000 to .0024 in. (0.00 – 0.061 mm)

II = .0025 to .0074 in. (0.064 to 0.189 mm)

III = .0075 to .0149 in. (0.191 to 0.378 mm)

IIII = .0150 to .0249 in. (0.381 to 0.632 mm)

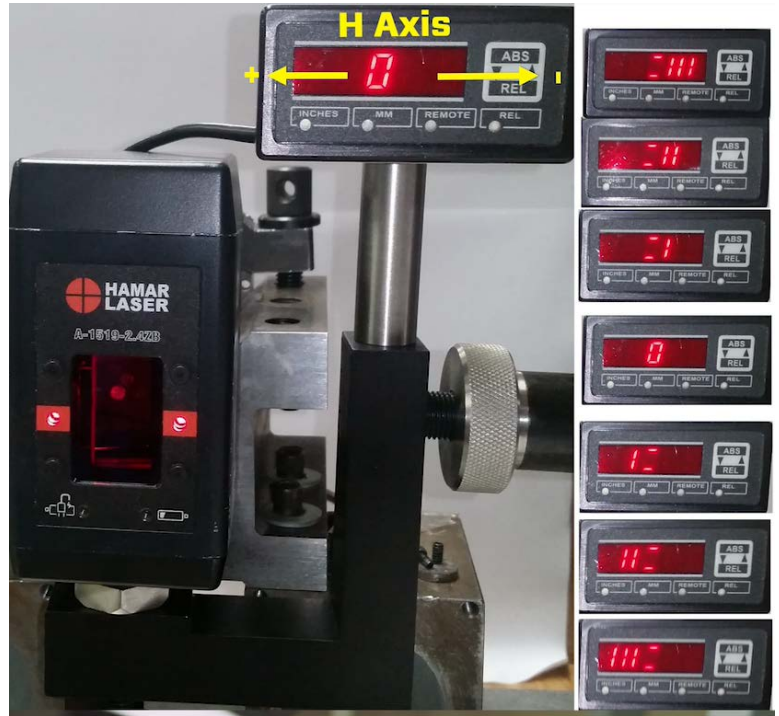

The image shows using the R-1308 with the A-1519 and A-1511 Wand Bore Fixture for steam turbine alignment. In this case, we recommend not letting the H axis be greater than 3 lines or .010 in. (0.25 mm) when taking the data.

# Performing a Turbine Alignment

---

## Preparing for an Alignment

There are several preparations that need to be made before beginning a measurement or alignment process. Ensure that accurate records are kept for all procedures.

## Hardware Preparation

- Determine what hardware is necessary to perform the alignment, including the laser, target, mounting fixtures, readouts or interface, cables, etc. Make a note of the target model number so that the information can be entered into the program setup.
- You will need to source multiple lengths of 2 in. (50 mm) angle iron to hold the A-502 Laser and Target Fixtures. You will need a set of 2 lengths of angle iron for the A-502L Laser Fixture and one set for the A-502A Target fixture. Measure the diameters for the bores (typically the oil bores) that will use the A-502 Fixtures and add about 12 in. to the diameter to allow for positioning of the Pacman Magnets (see Fig 8x) on a flat surface. *Note you can use a longer piece of angle iron on a shorter bore diameter but if there is too much hanging outside of the magnets, then it can cause instability in the fixture and drift in the measurements.*
- If a test or measurement is expected to take more than 3-4 hours, be sure to connect portable computers, interfaces, and other battery-operated devices to their external power supplies.
- Observe safety precautions when setting up hardware. Lockout machines for stationary procedures. If a machine is running, set up barriers and/or warning signs and route all cables away from moving parts. Clean and check all equipment, fixtures, and mounting surfaces before beginning any alignment process.

Turbine alignment is usually measured by referencing one bore on each end of the turbine shell and aligning the internal components to that centerline. In many cases, the oil seal housing is measured to the rotor shaft during disassembly and the alignment is performed based on the oil seal housing by setting the reference to the offset from the rotor shaft.

## Installing the “Pac Man” Magnets

Begin by placing one of each type of magnetic mount (one straight slot and one rotating slot) on the turbine shell beside the bearing reference bore, approximately 2.50 in. (64 mm) away from the flange face of the reference bore, with the slots facing away from the opposite reference bore. Turn the handle to lock the magnets (see page 10 for more details).

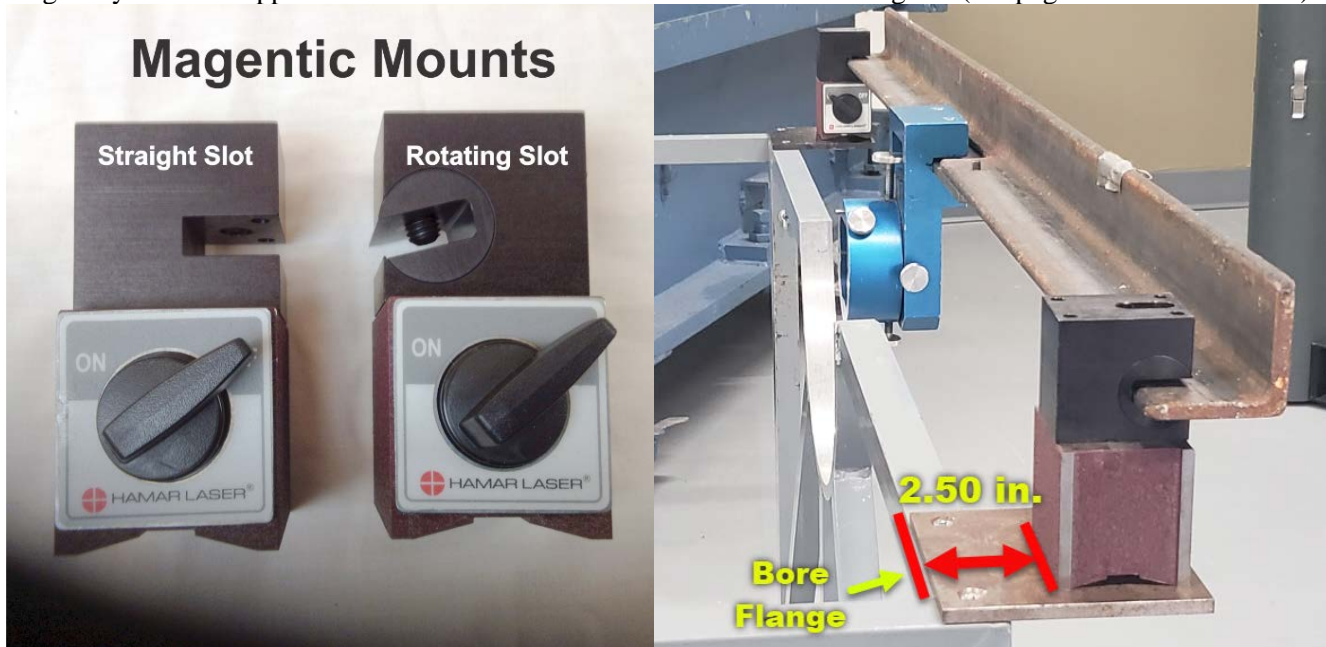

Figure 12 - Pac Man Magnets (left) & Mounting Dimensions (right)

## Center Adjustments for A-502A and A-502L

To maximize the center V & H axis adjustment range for the A-502A and A-502L, center the push-pull adjustments in the center of their range. To adjust them, loosen a thumb screw on one side and tighten the opposing thumb screw until the bolt head is centered in the slot.

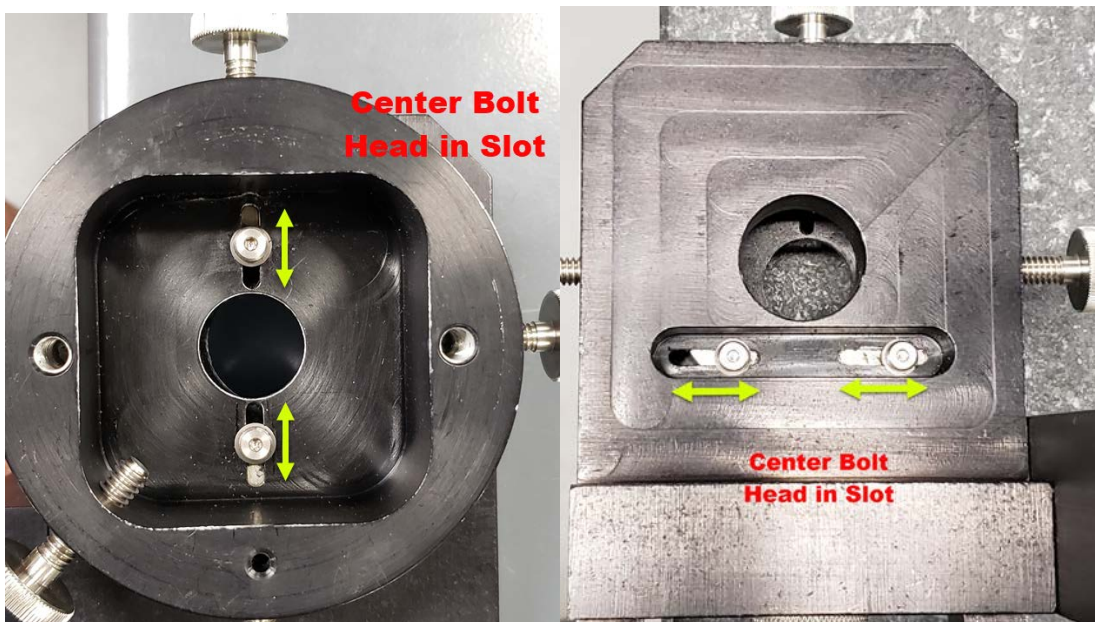

Figure 13 - A-502A/L V Axis (left) & H Axis (right) Adjustment Range

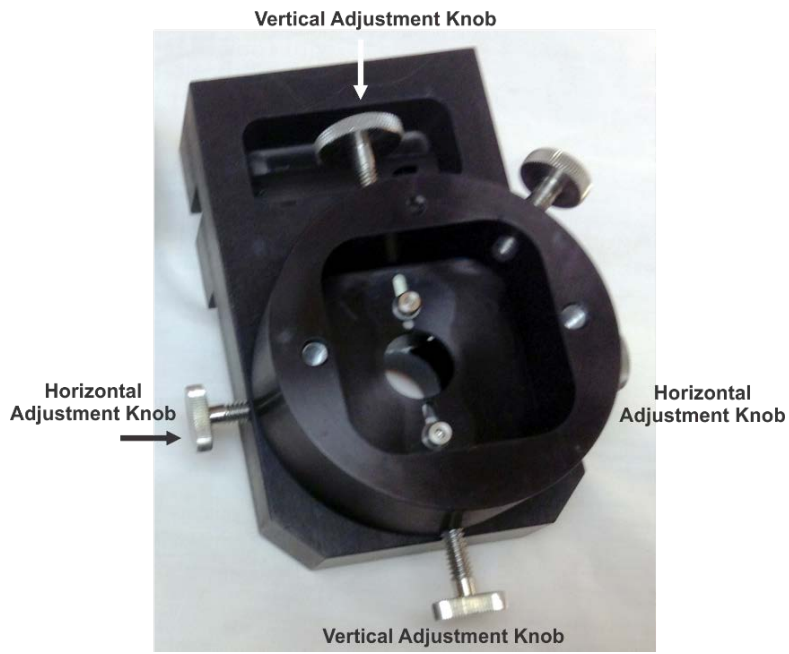
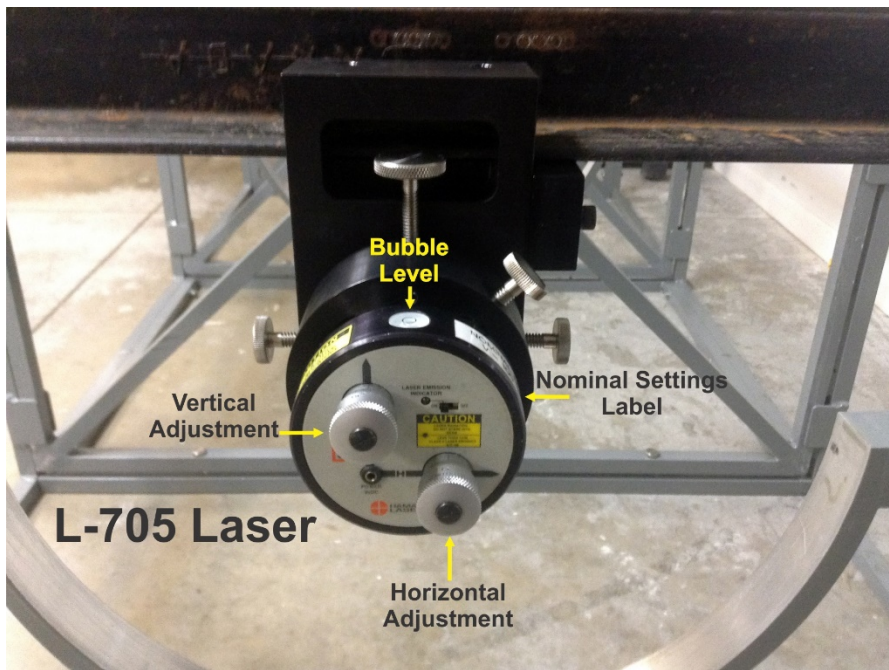

Figure 14 - A-502A/L Vertical & Horizontal Adjustments Knobs

## Installing the Pack-Man Magnets with Angle Iron

Cut lengths of angle iron to span the top of the turbine shell or reference bore. You will need about 5 inches (125 mm) of extra angle iron over the bore diameter.

- The A-502L requires 2 pieces of 2 in. x 2 in. (50.8 mm x 50.8mm) angle iron
- The A-502A requires 1 piece of 2 in. x 2 in. (50.8 mm x 50.8mm) angle iron



# Magnet Setup for A-502L Laser End

You will be setting up 2 lengths of angle iron with 4 Pac-Man magnets. You will need to place one set of the Pac-Man Magnets (one straight slot and one rotating slot) approximately 2.5 in. (64 mm) from the bore flange. Then place the second set about 8 in. (203 mm) towards the inside of the turbine and install another 2 in. x 2 in. (50.8 mm x 50.8 mm) length of angle irons into the slots and tighten the set screw. Tighten the straight-slotted magnetic mount *first*. Tighten the set screw in the rotating slot magnetic mount against the angle iron.

*Note – it is important to firmly tighten the set screws on the Pac-Man magnets and for the A-502A and A-502L fixtures. Loose fixtures will turn into laser beam drift that will move around the laser beam significantly.*



## Procedure to Set Up A-502L Pac-Man Magnets and Angle Iron

### Step 1 – Install First Set of Magnets and Angle Iron

Install Pac-Man magnets with the slots facing into the turbine about 2 in. ahead (inside) of the oil bore flange (face). Try to make the distance the same for each side to “square up” the angle iron to the centerline.

*First* tighten the set screw in the *straight-slotted* magnetic mount against the angle iron.

Then tighten the set screw on the other magnet that has the *rotating slot*. This magnet has a slot that rotates to allow for any angularity (twist) in the angle iron, so when tightening the set screws, it does not cause stress in the metal that can cause laser drift.

*Make sure the set screws are very tight.*

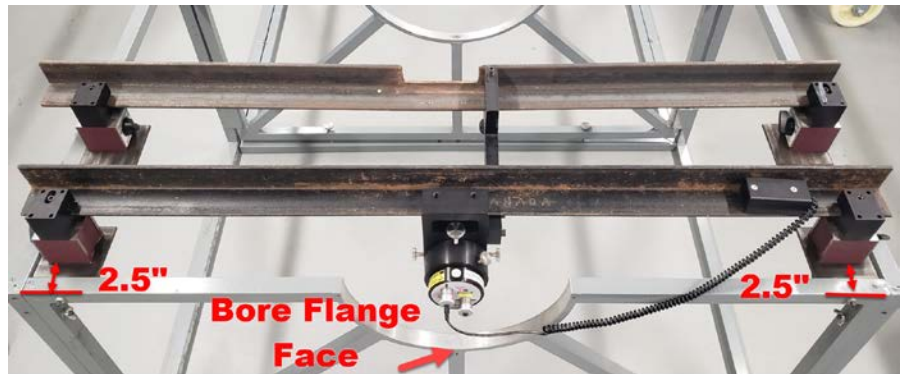

## Step 2 – Install 2<sup>nd</sup> Set of Magnets and Angle Iron

Install a second set of magnets approximately 8 in. (203 mm) from the front magnet towards the inside of the turbine. Measure from the front of the first magnet to the front of the second magnet. Make sure both sets of magnets are 8 in. (203 mm) apart.

Insert the angle iron and again tighten the straight-slotted side first, and then tighten the rotating side.

*Note – the second set of angle iron can be longer if the split joint is wider at this location.*

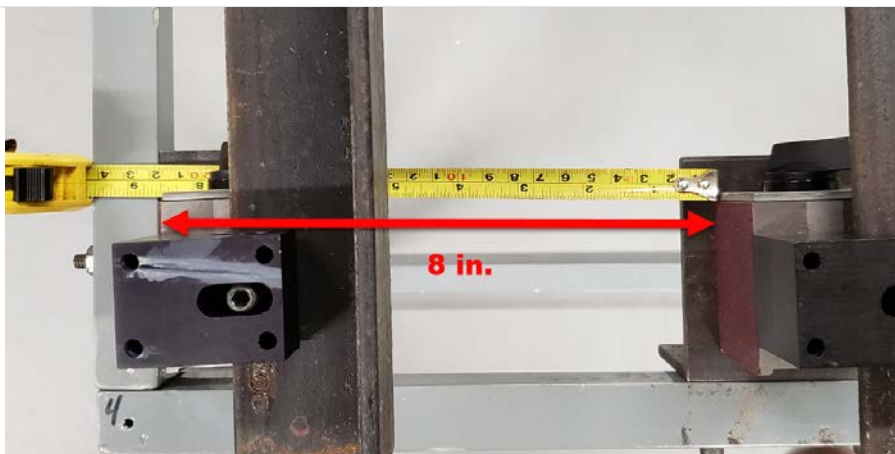

## Step 3 – Install the A-502L onto Angle Iron

Install A-502L onto the angle iron, as shown to the right.

*Note – make sure that the A-502L is “squared up” to the centerline of the turbine by pushing it against the edge of the angle iron and holding it in place when tightening the set screws. Tighten the screws slightly to hold the A-502L in place but allow it to slide along the angle iron.*

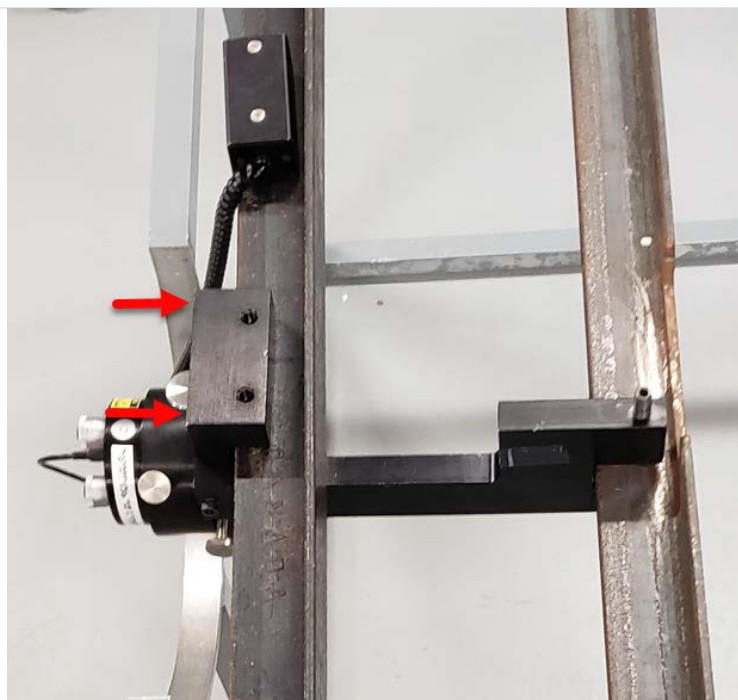

## Step 4 – Center A-502L to Bore

Using a tape measure, measure from the end of the bore to the side of the A-502L fixture, and slide the A-502L fixture left/right on the angle iron until the distance is the same from the left and right sides of the bore. This roughly centers the fixture to the bore. Next, we'll fine-tune the centering using the A-501(A) Sweep Fixture.

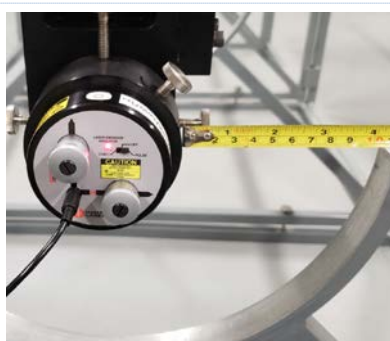

#### Step 4 – Use A-501A Sweep Unit to Roughly Center the A-502L to the Bore

Install the A-501A Sweep unit and roughly center the A-502L to the bore to about .020 in. There will be more rough-in adjustments to the fixture, so we'll do a final fine-tuning sweep when we get the A-502L aligned in angle to the centerline.

See page 21 for instructions on how to use the A-501(A) Bore Sweep Unit.



## Pac-Man Magnet Setup for A-502A (Target End)

Set the magnets so the slots are facing away from the laser end and about 2 in. (50 mm) inside the face of the bore.

Insert each end of 2 in. x 2 in. (50.8 mm x 50.8 mm) angle iron into the magnetic mounts. Again, *first* tighten the set screw in the *straight-slotted* magnetic mount against the angle iron. Then tighten the set screw on the other magnet that has the *rotating slot*.

*Make sure the set screws are very tight.*

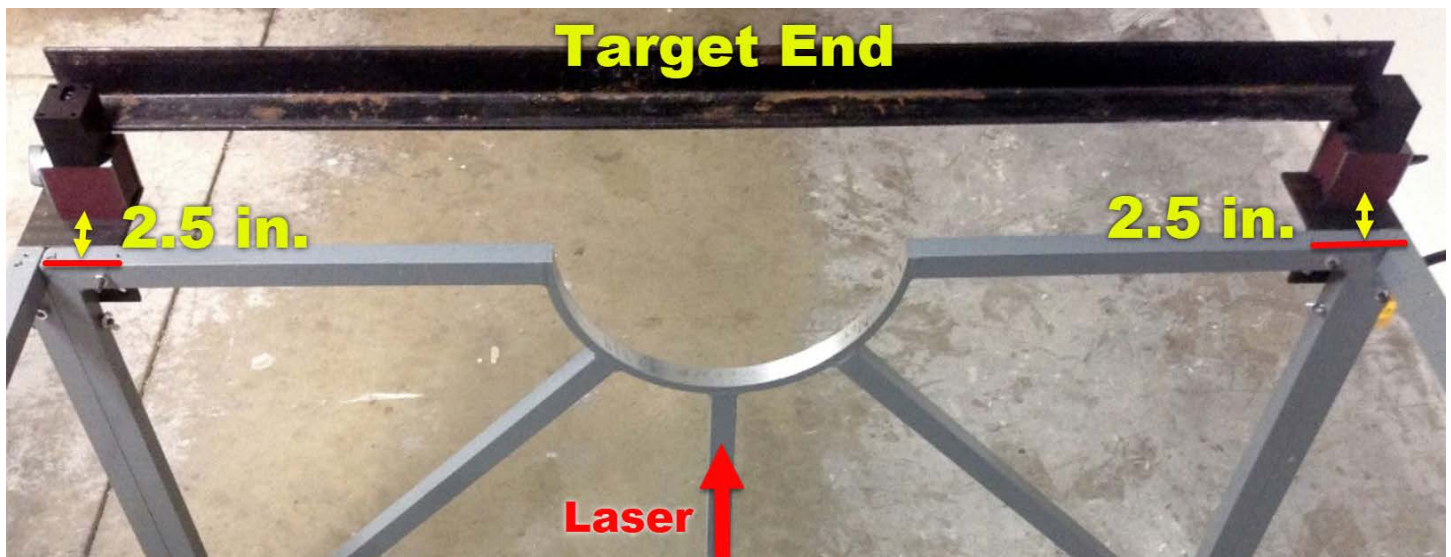



## How to use the A-501(A) Bore Sweep Unit

---

The A-501(A) is used to “sweep in” the A-502A or A-502L Fixtures to the center of the bore. It uses an electronic indicator and a sweep rod to measure the bores, so we can adjust the A-502A and A-502L so they are centered to the bores.

The procedure outline is this:

1. Sweep in the A-502A Target Fixture to zero.
2. Assuming the A-502L has been roughly centered to the bore, we need to roughly align the angle of the fixture, so it is parallel to the centerline.
3. Then, we sweep in the A-502L Laser Fixture to zero.
4. Fine-tune the angle of the laser by adjusting the micrometers until the readout shows zero.

***Note on repeatability** – to achieve good measurement repeatability, it is very important to mark your measurement points in the bore. You can use a Sharpie magic marker or some other method. We do not recommend using grease pencils due to the thickness of the grease, which can cause repeatability errors.*

### Procedure to Sweep in the A-502A or A-502L Into the Center of a Half Bore

#### **Step 1 – Insert the A-501(A) into the A-502A or A-502L fixtures.**

Insert the A-501(A) into the A-502A or A-502L fixtures. The A-502A has an alignment pin, so make sure the A-501(A) slides over the slot. The A-502L does not have a pin, so align the slot so it is at 12:00. However, it is ok if it's not perfectly aligned at 12:00.

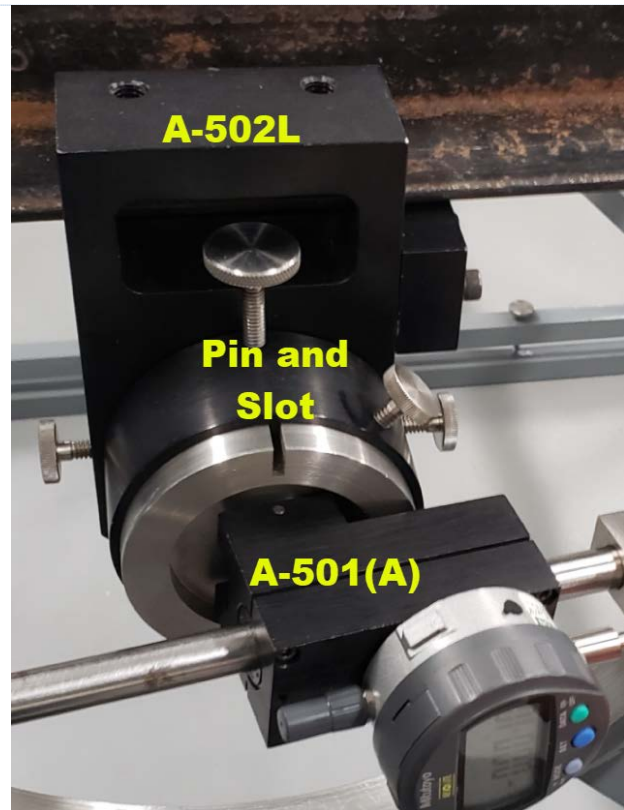

## Step 2 – Install Bore Sweep Rod, Indicator Pad and Bore Measurement Tip

Slide the stainless-steel **Bore Sweep Rod** into the A-501(A) and slide it through until a long section is hanging below the unit.



Slide on the Indicator Pad and then Bore Measurement Tip on the Bore Sweep Rod.

When sliding on the Indicator Pad, orient it so it's making contact with the indicator. Loosely tighten the thumb screw.

Slide on the Bore Measurement Rod Tip and orient as shown to the right. This puts the measurement tip on the rotation plane of the fixtures, maximizing accuracy.

Leave about .75 in. (19 mm) of Bore Sweep Rod length below the Bore Measurement Tip. This is used to bump against the flange face to keep the indicator measuring tip always the same distance away from the face of the bore.

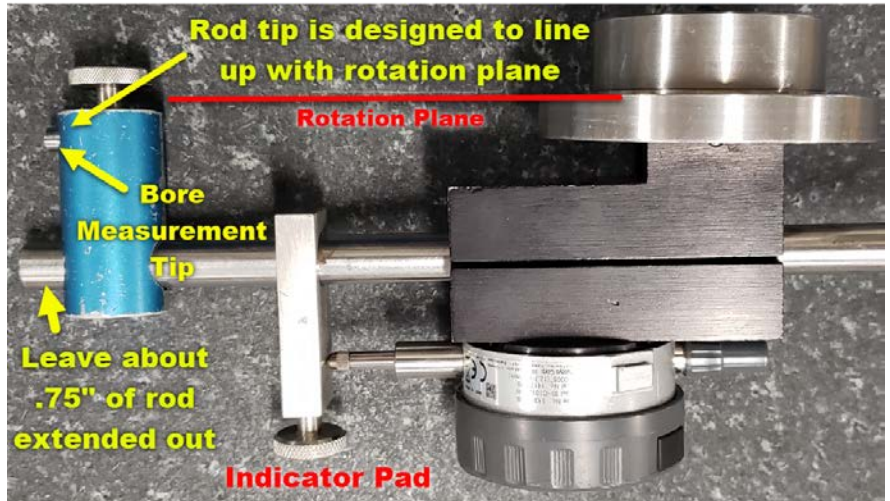

## Step 3 – Install the A-501(A) into A-502A or A-502L

Install the A-501(A) into A-502A or A-502L and let it hang down until the Bore Measurement tip touches the bore.



Move the Indicator Pad down and away from the indicator tip, so it's not touching it. Then, zero the indicator.

Next, adjust the Indicator Pad up/down until the indicator reads approximately .25 in (12.5 mm) and tighten the thumb screw firmly. This puts the indicator in the center of its measurement range.

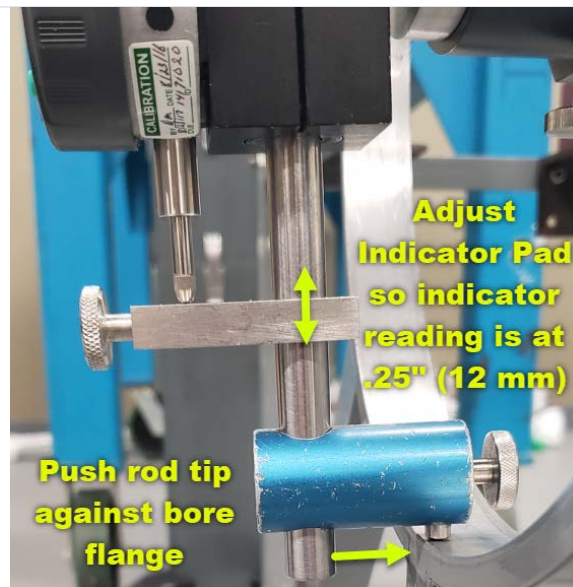

#### Step 4 – Move A-501(A) Rod to the Left Side and Zero Indicator.

Move the A-501A Rod to the left side and zero the indicator. Put a mark where the Bore Measurement Tip makes contact with the bore, so you can repeat the same location when taking more measurements to check repeatability.

**Note 1** – When selecting the measurement location, it is strongly recommended to inspect the surface to see if there are any bumps or pits in the surface. It's best to use a location on the surface that is clean and smooth.

**Note 2** – When placing the tip against the bore surface, pull the rod so the measurement tip makes contact with the ID surface. There is a special bearing in the A-501 that allows the rod to slide up/down but does not let it rotate. The movement up/down can be stiff at times, so be aware of that and always double-check that the tip is making contact with the bore surface.



**Step 4a - Sweep the A-501(A) to the right side to Take Measurement.**

Sweep the A-501(A) to the right side of the bore and note the measurement. Also, put a mark where the measurement tip makes contact with the bore to mark the measurement point.

Divide the measurement by 2 and this is the *Set Point for the H axis*.

**Step 4b – Adjust H Axis in A-502A/A-502L**

Loosen one H-Axis adjustment thumb screw and tighten the other, or vice versa, to move the fixture left/right, so that the indicator value equals the Set Point.

For example:

Indicator value right side: +.120 in.

Set Point =  $.120/2 = .060$  in.

Adjust the fixture until the indicator reads  $.060 \pm .001$  in.

Firmly tighten BOTH Adjustment Screws, but *don't overtighten*.

Rotate the A-501(A) Sweep Rod back to the left, where you should see the same .060 value. If it's not completely centered, then repeat this step.

If it reads  $.060 \pm .001$  in., then zero the indicator.

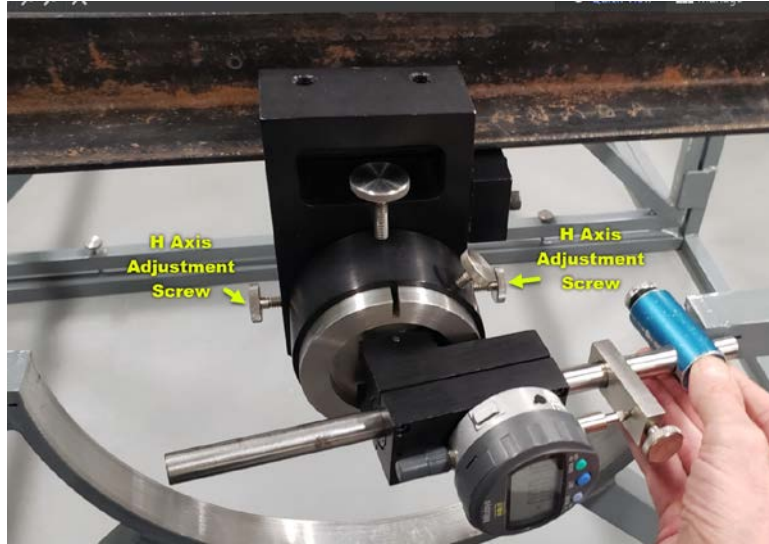

#### Step 4c – Adjust the V Axis Thumb Screws

After zeroing the indicator on the left side, rotate the sweep rod down to the bottom to get the measurement. Try to make sure the rod is plumb to the bore. Again, put a mark where the measurement tip makes contact with the bore.

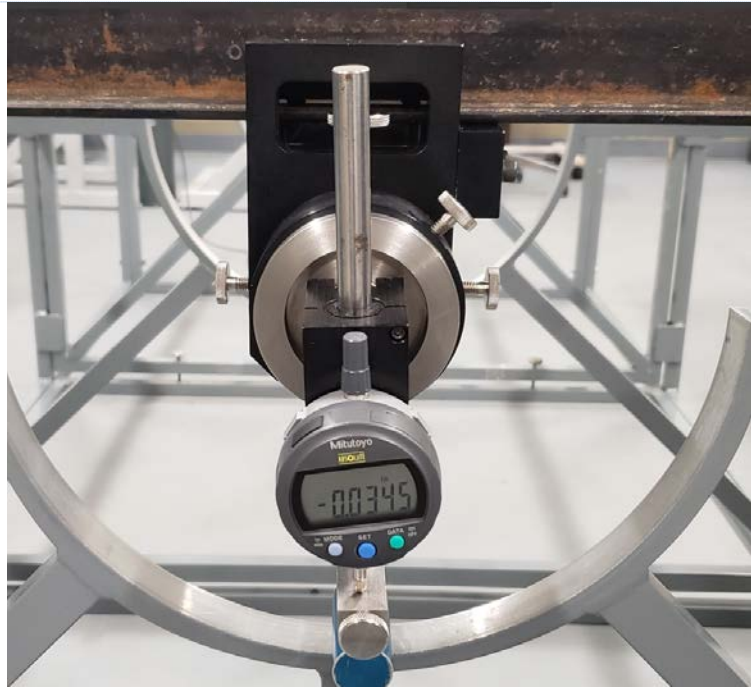

Now loosen/tighten the V Axis Adjustment thumb screws until the indicator reads  $.000 \pm .001$  in. (0.025 mm).

*Note - the picture to the right shows the indicator on the left side to allow us to see the V Axis Adjustment knobs.*

Sweep back to the left side to see if the indicator still reads  $.000 \pm .001$  in. Then, sweep back to the right side to make sure it also reads  $.000 \pm .001$  in., and again measure the bottom location. If the indicator reads  $.000 \pm .001$  in all 3 locations, then you're done!

Again, make sure to always put the measurement tip in the same marked location.

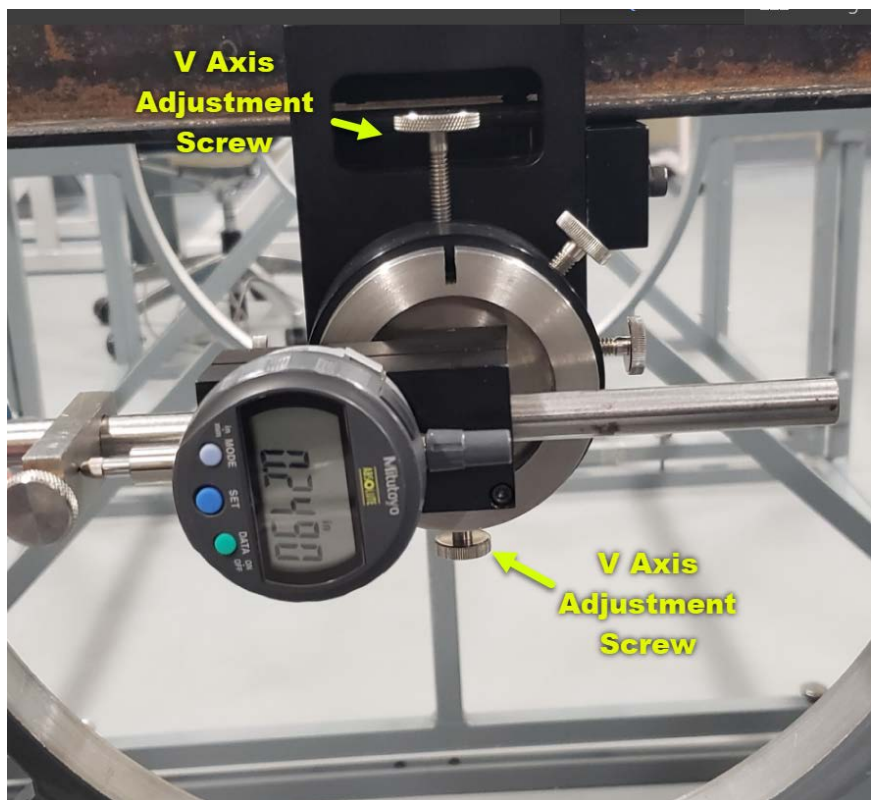

# How to Rough Align the A-502L

Before we can set up the laser for doing our alignments, we need to roughly align the angle of the laser beam to the centerline.

Here are the controls on the L-706/706 Laser that you'll need for the fine angular adjustment. The vertical and horizontal adjustments tilt the laser beam up/down and left/right in angle but do not affect the centering of the laser to bore.

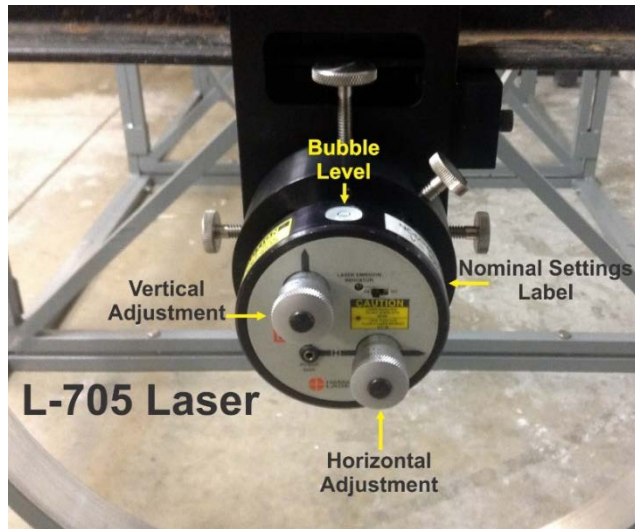

## Procedure to Rough Align the A-502L

### Step 1 – Set Up Pac-Man Magnets and Angle Iron

First set up the Pac-Man magnets and angle iron as shown on pages 15-19. Make sure to use the A-501(A) to roughly center the laser fixture to the bore as shown above.



### Step 2 – Sweep In A-502A and Install T-218T

Install the A-502A Target Fixture and use the A-501A Bore Sweep unit to sweep in the A-502A, as shown on pages 21-25.

When the A-502A is swept in, remove the A-501 Sweep Unit and install the T-218T, making sure to align the T-218T's slot with the pin in the A-502A.

Connect the R-1307-2.4XBE and turn it on.



### Step 3 – Install L-706 into A-502L

Set the L-705 micrometers to the Nominal Settings as shown on the laser flange – see Page 4.

Install the L-706 into the A-502L Fixture and make sure the level vial on the top is level from left to right, but don't worry about front to back.

Plug in the battery pack and turn on the laser in CONT. Mode.

*Note – CONT. Mode is used in rough alignment because it is easier to see than Pulsed (blinking) Mode.*



### Step 4 - Roughly Align Vertical Axis

Note where the beam is located relative to the T-218T Target. It will most likely be low.

Next, loosen the tightening screw on the bottom of the A-502L.

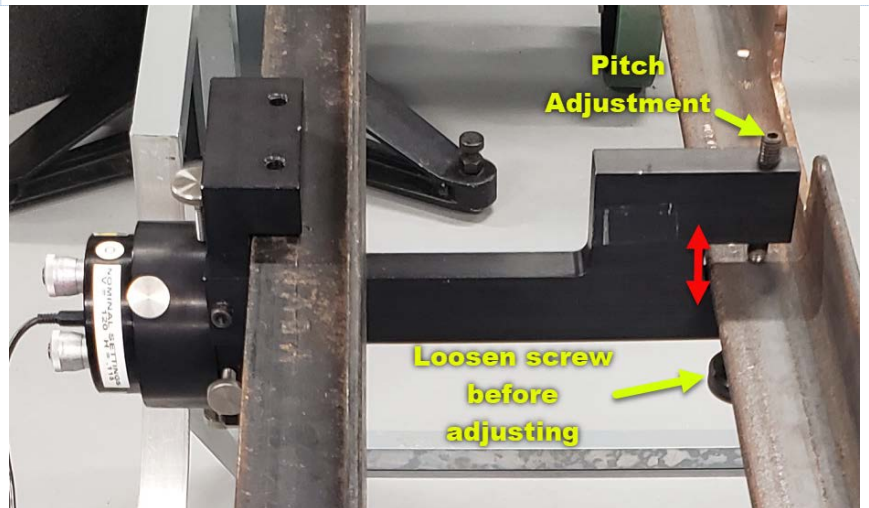

Then, using the A-502L's Pitch Adjustment, and watching the laser beam, adjust the pitch adjustment (up/down) of the laser until the laser beam appears to be centered vertically in the target (see the image to the right).

When this is done, lightly tighten the thumb screw on the bottom of the A-502L to stabilize the fixture.

We need to leave the thumb screw somewhat loose, so we can roughly adjust the horizontal angle of the laser by sliding one of the magnets along the surface. See the next step.



### Step 5 - Roughly Align Horizontal Axis

Now turn off one of the Pac Ma mag bases, usually the one where the laser is, and push or pull it to adjust the horizontal angular position of the laser beam until you see it go into the T-218T's window.

At this point, switch the L-706 to Pulsed Mode and you should see readings on the R-1307 Readout. Try to get both the V and H axes to within  $\pm 0.050$  in. or so of zero.

In the next step, you will fine-tune the laser alignment to zero, so .050 in. is close enough.

The A-502L is now roughly aligned to the T-218T and, next, we will sweep it into the bore center.

***Important:*** Now turn on the magnet again and make sure to tighten the bottom thumb screw for the vertical axis.

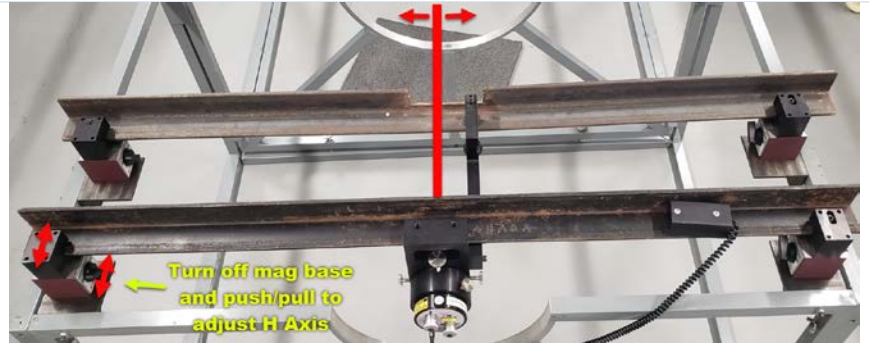



# Final L-706 Laser Buckin to T-218T Target

Now that the L-706 laser is roughly bucked into the T-218T Target, we'll need to dial it in to zero at both ends.

## Procedure to Fine Buckin L-706 to T-218T

### Step 1 – Sweep in A-502A and Install T-218T

If it hasn't already been done, sweep in the A-502A Fixture to the bore at the target end to  $\pm.001$  in. – see pages 21-25. Then install the T-218T and connect it to the R-1307-2.4XBE Readout and turn it on. Make sure the R-1307 is set to P 10.10 (Pulsed Mode).



### Step 2 – Sweep in A-502L and Install L-706

Now we'll fine tune the bore centering for the A-502L fixture by using the A-501(A) to sweep it into the bore to  $\pm.001$  in. – see pages 21-25. Remove the A-501(A) and install the L-706 into the A-502L, ensuring its level (left/right). Turn on the L-706 in Pulsed Mode. Now, you should see readings on the target.



### Step 3 – Adjust the V & H Axis on the L-706

Now adjust the Vertical and Horizontal micrometers to adjust the pitch and yaw axis of the laser until the readout shows  $.000 \pm .001$  in. in 33 feet,  $\pm.002$  in 66 feet and  $\pm.003$  in 100 feet. The laser is now bucked in, and you are ready to take measurements.

**Note** – if you run out of adjustment range with the laser (i.e. you turn the micrometers but the numbers don't change), then you will need to redo the Rough Align the A-502L procedure, on pages 27-28.

The L-706 has  $\pm.0125$  in/ft of adjustment range, so at 10 feet, the rough angular alignment needs to be better than  $\pm.125$  in.

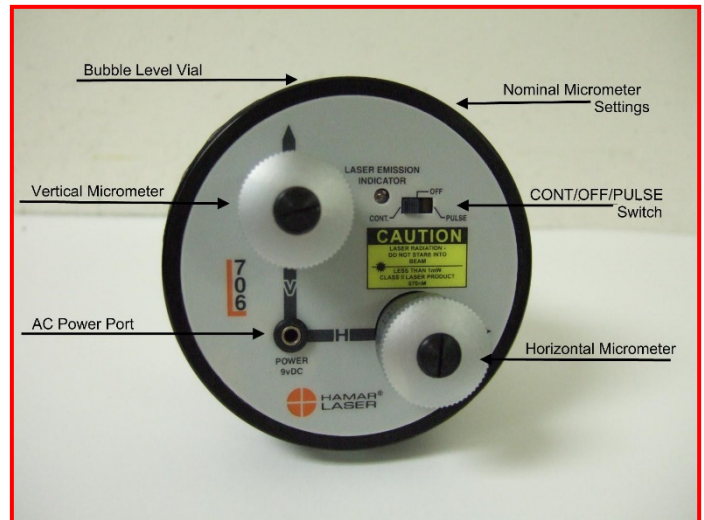

# How to Take Data with the T-218T/A-502A/A-501A

There are two ways to take the bore data with the L-706 Steam Turbine System. The first is to use a second T-218T Target and A-502A Half-Bore Fixture, along with the A-501(A) Bore Sweep Fixture. The second way is to use the A-1511 Wand Bore Fixture and an A-1519-2X-2.4XBE Wireless Target – see pages 33-39 below.

## Procedure to take data with the -218T/A-502A/A-501A

### Step 1 – Install the A-502A and T-218T

Install the Pac-Man magnets as shown in *Pac-Man Magnet Setup for A-502A (Target End)* on pages 17-20. Then, install the A-502A and rough it into the center, as shown on page 16. Install the T-218T into the A-502A and tighten it in place. Connect the R-1307 Readout and make sure you have numbers. If you don't get numbers, then loosen the screws on top of the A-502A and slide it left/right until you see numbers. Tighten the set screws.



### Step 2 – Adjust the A-502A/T-218T to Zero

Now as we did above, start adjusting the Vertical and Horizontal axes by loosening one thumb screw and tightening the opposing screw. Adjust both axes until readout shows zero or within  $\pm 0.001$  in.

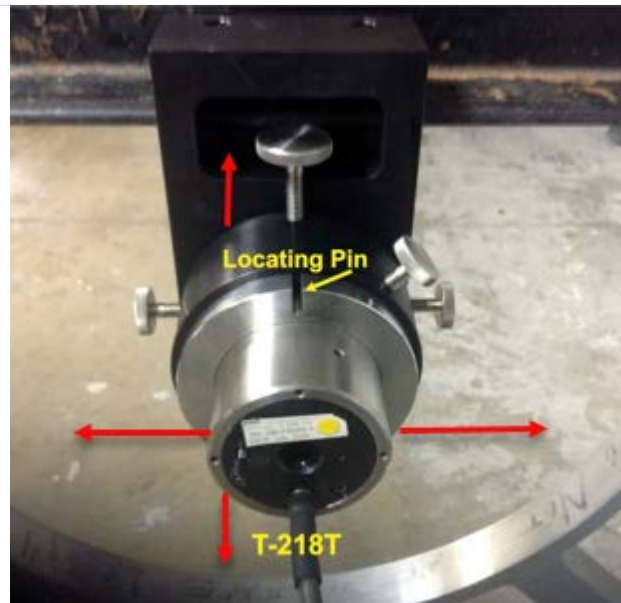

### Step 3 – Take out T-218T and Install A-501(A)

Take out the T-218T and install the A-501(A) (see page 18 for details on the A-501A setup). Sweep the measuring rod over to the *left* side and zero it.

*Note – make sure to push the Bore Sweep Rod against the flange face of the bore at all locations. This keeps the measurement tip always the same distance away from the flange face and helps with repeatability.*

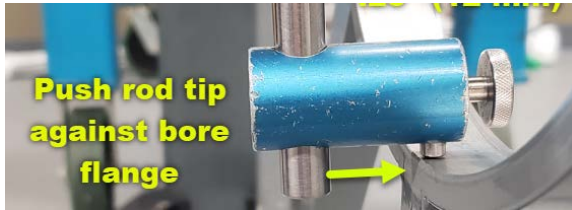

Then, sweep it over to the *right* side, write down the measurement, making sure to note the sign!

Sweep it down to the bottom (6:00) and write down the measurement.

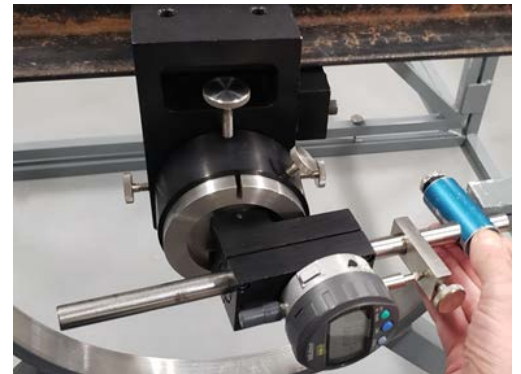

### Calculating the Bore Misalignment - An Example

- Left side of indicator reading = .000 in.
- Right side of indicator V reading = +.026 in.
- Bottom of indicator V reading = -.045 in.

- Horizontal axis alignment =  $(\text{left} - \text{right}) / 2 = (.000 - .026) / 2 = -.013$   
The component bore center is to the left of the centerline (laser beam) by -.013 in. when looking into the T-218T from the Laser.
- Vertical axis alignment =  $\text{Bottom Value} - \text{Horiz Value} = -.045 - -.013 = -.032$   
The bore center is low by -.032 in. relative to the centerline (laser beam).

# How to Take Data with A-1511 Wand Bore Fixture

There are two ways to take the bore data with the L-706 Steam Turbine System. The first is to use the T-218T Target mounted in the A-502A Half-Bore Fixture and the A-501(A) Bore Sweep Fixture, which is detailed on pages 30-31. The second is to use the A-1511 Wand Bore Fixture and an A-1519-2X-2.4XBE Wireless Target.

In this method, we'll be using an L-shaped bracket (A-1511) to hold our A-1519-2.4XBE-2X Target so we can "sweep it through the arc" in a very similar manner that is done when using an inside micrometer and tight wire. First, we will put the A-1511 measuring tip on the left side of the component, sweep it through the arc, and then zero the display for the Horizontal axis. Then, we flip the A-1511/A-1519 fixture around to put it on the right side of the component and sweep it to get the H-axis value. Finally, we move the A-1511 measuring tip to the bottom of the component and sweep the V axis. Then, we do a bit of quick math to get the results. A more detailed procedure follows below.

See the next page to see a list of A-1511 Fixture leg lengths and other dimensions.

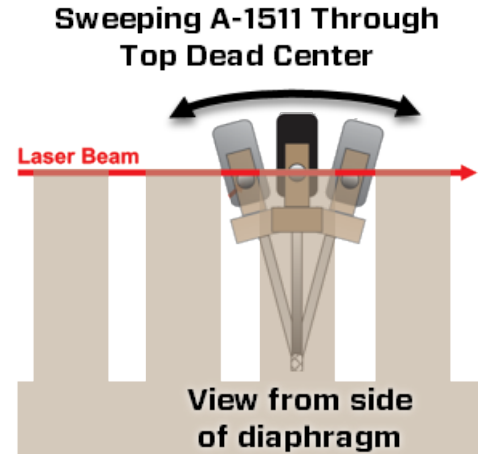
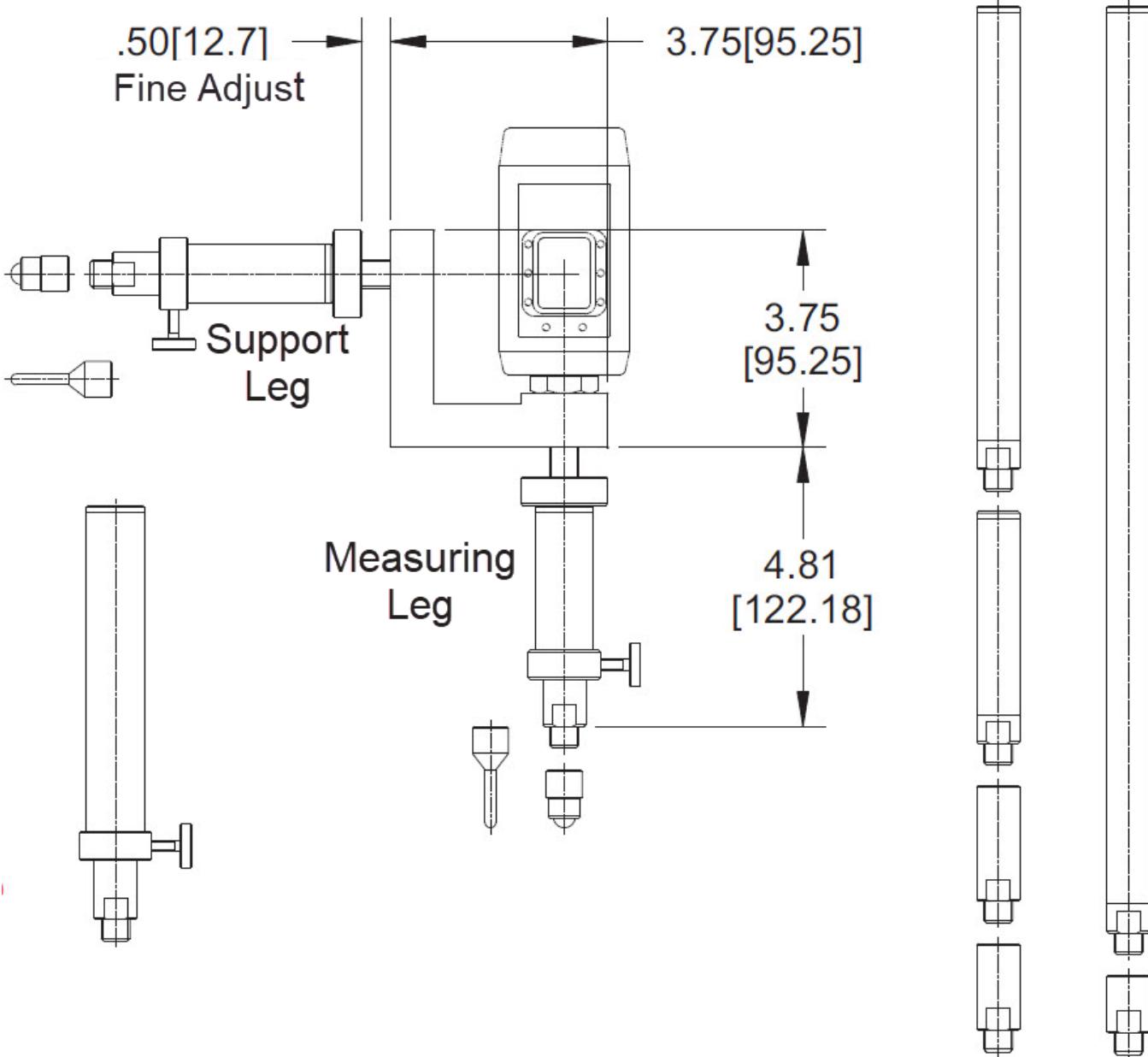

Figure 15 - A-1511 Wand Bore Fixture & A-1519-2.4XBE-2X Target



A-1511AWandBoreFixture  
 UsedwiththeA-1519UniversalTarget  
 MinimumBoreDiameter: 10.00"[254mm]  
 MaximumBoreDiameter: .96.00"[2.4m]

- Includes:
- (1)A-1519MountingBracket
  - (2)4.00"[101.6mm]CoarseAdjustExtensions
  - (2)1.00"[25.4mm]CoarseAdjustExtensions
  - (2)16.00"[406.4mm]LongExtensions
  - (2)8.00"[203.2mm]LongExtensions
  - (2)4.00"[101.6mm]LongExtensions
  - (2)2.00"[50.8mm]LongExtensions
  - (2)1.50"[38.1mm]LongExtensions
  - (2)1.00"[25.4mm]LongExtensions
  - (2)1.00"[25.4mm]LongBallTips
  - (2)1.75"[44.5]Long.19[4.8mm]DiaSphericalTips

Figure 16 - A-1511 Wand Bore Fixture Dimensions

## Using the R-1308 Readout Display-Mode Button for the A-1511

The R-1308's Display-Mode button is used when using the A-1519-2.4XBE target in 2-axis mode. By pressing the Display Mode button, the readout is switched from showing the V-axis data (actual numbers) to showing the H-axis data, which is represented by lines. Each line equals the values shown below. If the lines appear to the *right* of zero, then this means the target is to the *right* of the laser beam when looking into the front of the target, and vice versa.



The lines equal the distance from the center of the target in the H axis as shown below:

□ = zero

I = .000 to .0024 in. (0.00 – 0.061 mm)

II = .0025 to .0074 in. (0.064 to 0.189 mm)

III = .0075 to .0149 in. (0.191 to 0.378 mm)

IIII = .0150 to .0249 in. (0.381 to 0.632 mm)

The image shows using the R-1308 with the A-1519-2.4XBE-2X and A-1511 Wand Bore Fixture for steam turbine alignment. In this case, we recommend not letting the H axis be greater than 3 lines or .010 in. (0.25 mm) when taking the data.

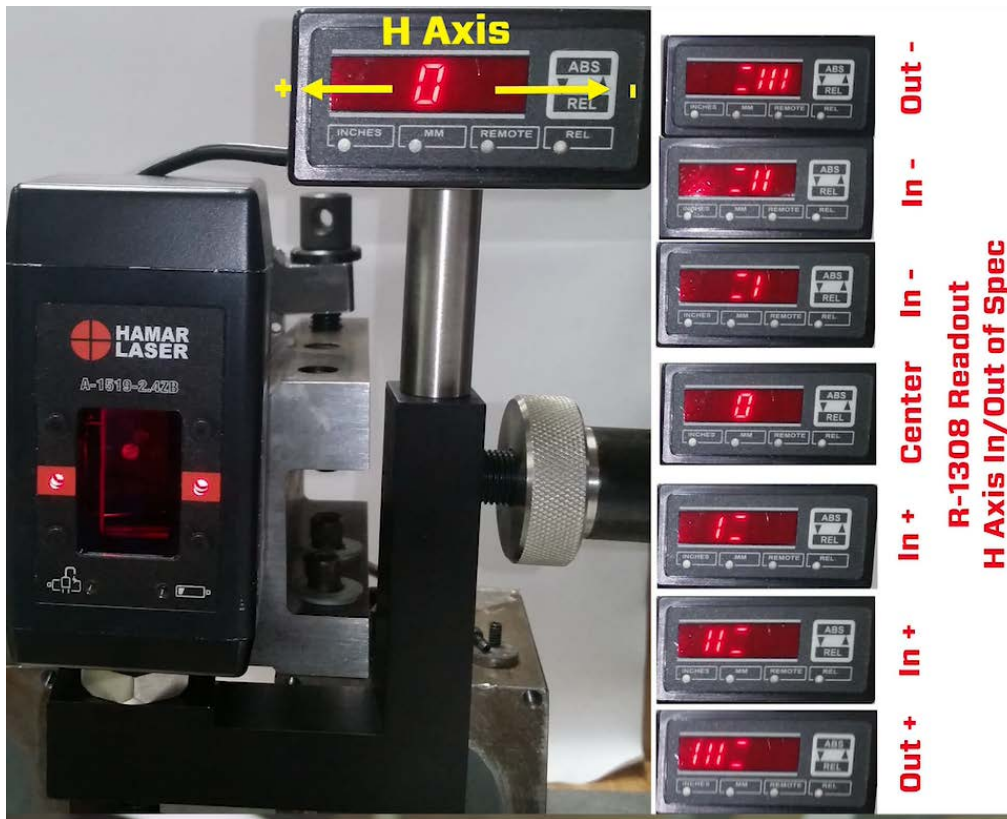

# Data-Taking Procedure with the A-1511/A-1519-2X-2.4XBE & R-1308 Readout

**Important Note** – Before using the A-1511 Wand Bore Fixture, it is necessary that the internal component be pre-aligned to the bore centerline to better than  $\pm 0.125$  in. ( $\pm 3.18$  mm). If it is outside of this range, then the measuring range of the target will be exceeded and this procedure will be difficult. In cases where this alignment tolerance cannot be easily achieved, then we recommend using the T-218/A-502A and A-501A to check the alignment.

## Step 1 – A-1511 Set Fixture Legs to Nominal Values

We need to set the measuring leg and the support leg of the A-1511 Wand Bore Fixture to the nominal bore radius. So, using a measuring tape, measure the diameter of the bore and divide by 2 to get the radius.

Then select the appropriate legs and/or extensions that can be adjusted to the radius of the bore, minus 3.750 in. (95.25 mm) – see the drawing on page 33. The 3.75 in. dimension is the distance from the leg attach point of the L-bracket to the outside of the target window.

Attach these legs to the A-1511 Wand Bore Fixture.



## Step 2 – Adjust the Legs to the Radius

Using the tape measure, measure from the approximate center of the target to the tip of the Measuring Leg. Loosen the thumb screw and adjust the legs so it equals the radius. Repeat this for the Support Leg.

*Note* - the LEDs on the front of the target are the zero point on the PSD sensor, so measure from there to the target tip.



## Step 3 – Attach the R-1308

Attach the R-1308 Readout and plug it into the side of the A-1519-2x-2.4XBE Target. Turn on the target by pressing the *Zero Button* on the side of the target.



On the top of the R-1308 there is a Display Mode Button. Press the **Display Mode** Button (see Page 34) on the readout to change the readout to Display Mode (the vertical lines).



#### Step 4 – Set the Support Leg

Place the Measuring Leg against the left (or right) side of the bore in the location you want to measure. Place the support leg so it rests on the bottom of the component.

Adjust the Support Leg until there are < 3 bars showing. Then, slowly sweep the fixture towards and away from the laser, noting the highest number of bars displayed. If the number of bars is >3, adjust the Support Leg until it reads 2 bars or less. Sweep it again to verify.

#### Sweeping A-1511 Through Top Dead Center

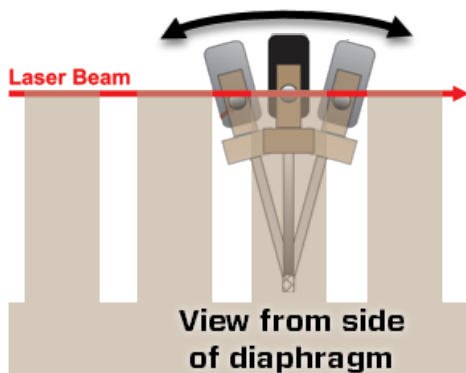

*Note – a bullseye level has been provided that can be attached to the A-1511 to help “square up” the fixture when adjusting the support leg.*

*Also, keep the face of the target flush with the fixture.*





### Step 5 – Zero the Target on the Left (Right) Side

Press the **Display Mode** Button again to change the display to actual numbers for the V axis. Adjust the Measuring Leg until the readings are near .000 (within +/- .010").

Then, slowly sweep the fixture/target toward/away from the laser until you get the highest number reading on the R-1308 Readout. When you have the highest reading on the readout, press and hold the **ABS/REL** Button on the front of the R-1308 to zero the reading.

*Note* – you can also zero the display by pressing and holding the Zero Button on the side of the A-1519-2.4XBE-2X-II Target.

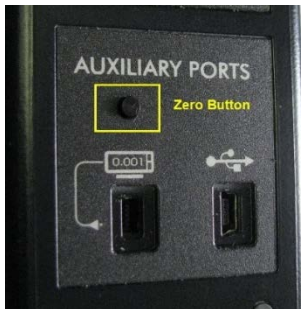

### Step 6 – Measure the Right (Left) Side – Horizontal Value

Flip the A-1511/A-1519 around 180 degrees so the Measuring Leg is on the right (left) side of the component.

#### *Note*

- You will have to rotate the target 180 degrees on the bottom rotation nut, so it faces the laser.
- Be sure to note whether the number is positive (+) or negative (-).

Again, slowly sweep the target toward/away from the laser and note the highest value. This is the raw reading for the right side, or the Horizontal Axis.



### Step 7 – Measure the Bottom – Vertical Value

Move the Measuring Leg to the bottom of the component and the Support Leg to the left side.

Again, slowly sweep the target toward/away from the laser and note the highest value. This is the raw reading for the bottom of the component or the Vertical Axis.

**Note:** Be sure to note whether the number is positive (+) or negative (-).



## Calculating the Bore Misalignment

Now that we have the 3 readings (left, right and bottom), we can calculate the alignment of the bore center relative to the laser beam.

1. Calculate the Horizontal-Axis alignment value

$$H = (\text{left side measurement} - \text{right side measurement})/2$$

$$\text{Vertical axis alignment} = \text{Bottom measurement value} - H \text{ axis alignment value}$$

### Example

- Left side of bore target V reading = .000 in.
- Right side of bore target V reading = +.026 in.
- Bottom of bore target V reading = -.045 in.
  
- Horizontal axis alignment =  $(\text{left-right}) / 2 = (.000 - .026) / 2 = -.013$   
The bore center is to the left of the centerline (laser beam) by -.013 in. when looking into the target.
  
- Vertical axis alignment =  $\text{Bottom Value} - \text{Horiz Value} = -.045 - -.013 = -.032$   
The bore center is low by -.032 in. relative to the centerline (laser beam).

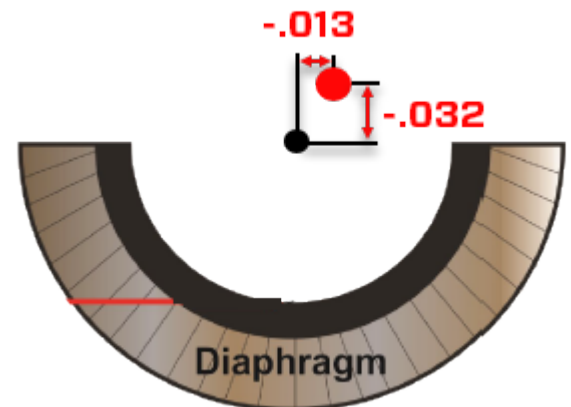

# Measuring Bores Using the A-1511/A-1519-2.4XBE-2X & R-1307 Readout

Ensure that the R-1307-2.4XBE Readout is configured correctly for the A-1519-2.4XBE-2X Wireless Target. See Appendix B, beginning on Page XX for configuration instructions.

When using the R-1307 Readout, there will be both Vertical and Horizontal axis measurements, so you don't have to use the 'bars' that you had to use with the R-1308. This means when adjusting the H axis, we'll use the H-axis value to indicate if the support leg has been set to the proper length.

*Note: when using the R-1307, you only record the target's V axis.*

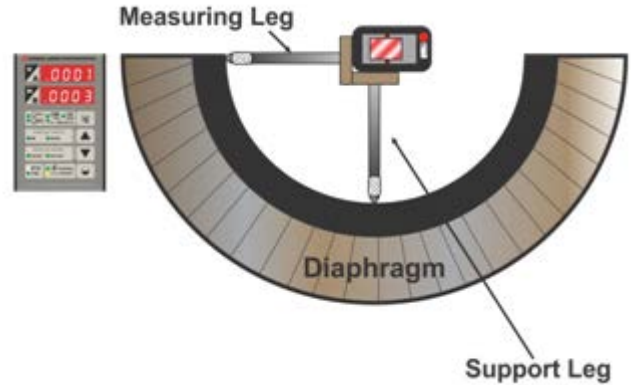

## Step 1 – A-1511 Set Measuring Legs to Nominal

We need to set the measuring leg and the support leg of the A-1511 Wand Bore Fixture to the nominal bore radius. So, using a measuring tape, measure the diameter of the bore and divide by 2 to get the radius.

Then select the appropriate legs and/or extensions that can be adjusted to the radius of the bore, minus 3.750 in. (95.25 mm) – see the drawing on the page 34. The 3.75 in. dimension is the distance from the leg attach point of the L-bracket to the outside of the target window.

Attach these legs to the A-1511 Wand Bore Fixture.



## Step 2 – Adjust the Legs to the Radius

Using the tape measure, measure from the approximate center of the target to the tip of the measuring leg. Loosen the thumb screw and adjust the legs so it equals the radius. Repeat this for the second leg.

*Note - the LEDs on the front of the target are the zero point on the PSD sensor, so measure from there to the target tip.*



### Step 3 – Connect the R-1307-2.4XB

Turn on the target by pressing the *Zero Button* on the side of the target. Connect the R-1307 Readout to the A-1519-2.4XB-2X Target (see Appendix B on page xx for configuration details).

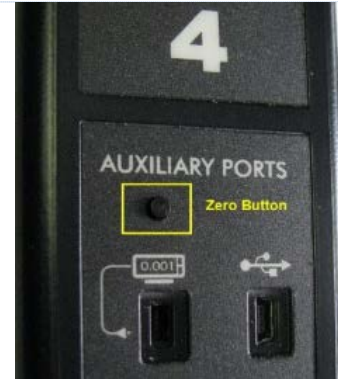

### Step 4 – Set the Support Leg

Place the measuring tip against the left (or right) side of the bore in the location you want to measure. Place the support leg so it rests on the bottom of the component.

Adjust the support leg until the R-1307's H-axis value is zero within  $\pm 0.010$  in. (0.25mm). Then, slowly sweep the fixture towards and away from the laser, noting the highest display value. If the number is  $\geq \pm 0.010$  in. (0.25 mm), adjust the support leg again until it reads .010 (0.25 mm) or less. Sweep it again to verify.



Adjust the Support Leg until the H-Axis display shows  $< .010$ " (0.25 mm)

### Sweeping A-1511 Through Top Dead Center

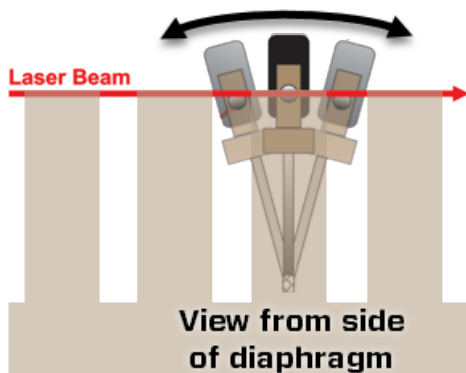

### Step 5 – Zero the Target on the Left (Right) Side

Adjust the measuring leg until the V-Axis readings are near .000 (within +/- .010").

Then, slowly sweep the A-1511 fixture/target toward/away from the laser until you get the highest number reading on the R-1307-2.4XBE. When you have the highest number reading on the readout, press the **Zero Button** on the side of the A-1519-2.4XBE-2X to zero the reading.

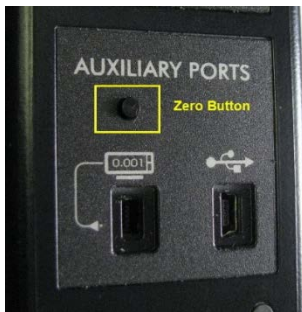

### Step 6 – Measure the Right (Left) Side – Horizontal Value

Flip the A-1511/A-1519 around 180 degrees so the measuring tip is on the right (left) side of the component.

#### Note

- You must rotate the target 180 degrees on the bottom rotation nut, so it faces the laser.
- Be sure to note whether the number is positive (+) or negative (-).

Again, slowly sweep the target toward/away from the laser and note the highest value. This is the raw reading for the right side or the Horizontal Axis.



### Step 7 – Measure the Bottom – Vertical Value

Move the Measuring Leg to the bottom of the component and the Support Leg to the left side.

Again, slowly sweep the target toward/away from the laser and note the highest value. This is the raw reading for the bottom of the component or the Vertical Axis.

**Note:** *Be sure to note whether the number is positive (+) or negative (-).*

See page 39 for the calculations for the H & V alignment values.



## Full Bore Accessories.

There are times when a “tops on” alignment check must be done. In this case, you’ll need to assemble the A-502 Fixtures in full bore mode. You will need 2 sets of angle iron for each bore diameter.

### Step 1 – Remove Support “Fork”

The front support “fork” on the A-502L will have to be removed to use the A-502L in Full Bore mode.



### Step 2 – Assemble the Angle Iron

Assemble the angle iron into the fixtures as shown here. You will need one fixture for the top and the bottom.

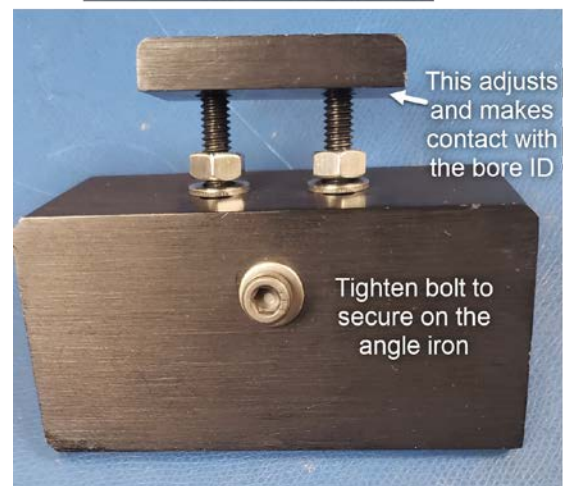
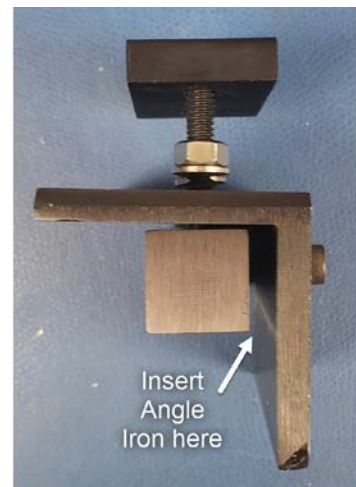

### Step 3 – Adjust Support Plate

Using a tape measure, measure the ID of the bore location where you want to install the A-502L or A-502A. Adjust the support plate to be 1 in. (25 mm) less than the bore ID.

Install the angle iron in the bore and adjust the plates using the set screws until it is rigidly mounted in the bore with no movement when shaken.





#### Step 4 – Install the A-502A or A-502L

Install the A-502A or A-502 L onto the angle iron as shown. Using a tape measure, roughly align the A-502A or A-502L to the center of the bore, as shown on pages 16-17.



**Step 5 – Install the A-501 Bore Sweep Unit and Sweep in A-502 Fixtures**

As shown on pages 20-24, center the A-502L or A-502A to the center of the bore.



**Step 6 – Continue Setup and Measure Bores**

As shown above on pages 24 and thereafter, follow the same procedures to take the bore data.

# Appendix A – The NORMIN Method (Bore and Spindle)

The NORMIN method was developed by Hamar Laser Instruments as a way of compensating for laser or target mounting errors in bore or spindle work. The word is a contraction of “NORMAl-INverted,” which briefly describes the method. It is quite similar to the four clock readings taken with dial indicators, but uses a laser and a target instead. The NORMIN method is used in conjunction with simple fixtures and targets that allow inexpensive, precision measurement. The target/fixture is set in the bore or spindle in the NORMAl position (cable down) and the readings are recorded. Then the target/fixture is rotated 180 degrees to the INverted (cable up) position, and a second set of readings is obtained. The two sets of readings cancel out centering errors and provide a very accurate result.

There are three centers involved in bore alignments: the True Bore Center, the Target Center, and the Laser Reference Centerline. If mounting fixtures were perfect, the Target Center would be located at the True Bore Center, and if perfectly aligned, the True Bore Center would be located at the laser beam center. In reality, however, they seldom line up.

Two relationships can be calculated from these three centers and two sets of NORMIN readings: the Target Sensor Concentricity Error (TSCE) and the True Bore Misalignment (TBM). The True Bore Misalignment (TBM) is used when it is desirable to know the true bore centerline position relative to the laser beam center without fixture errors. Usually, the laser beam center is where a bore center *should* be located, and the TBM shows its *actual* location. The Target Sensor Concentricity Error (TSCE) is used if the operator wants to place the laser beam center exactly in the middle of a bore.

The general rule is: buck in to the TSCE and measure the TBM.

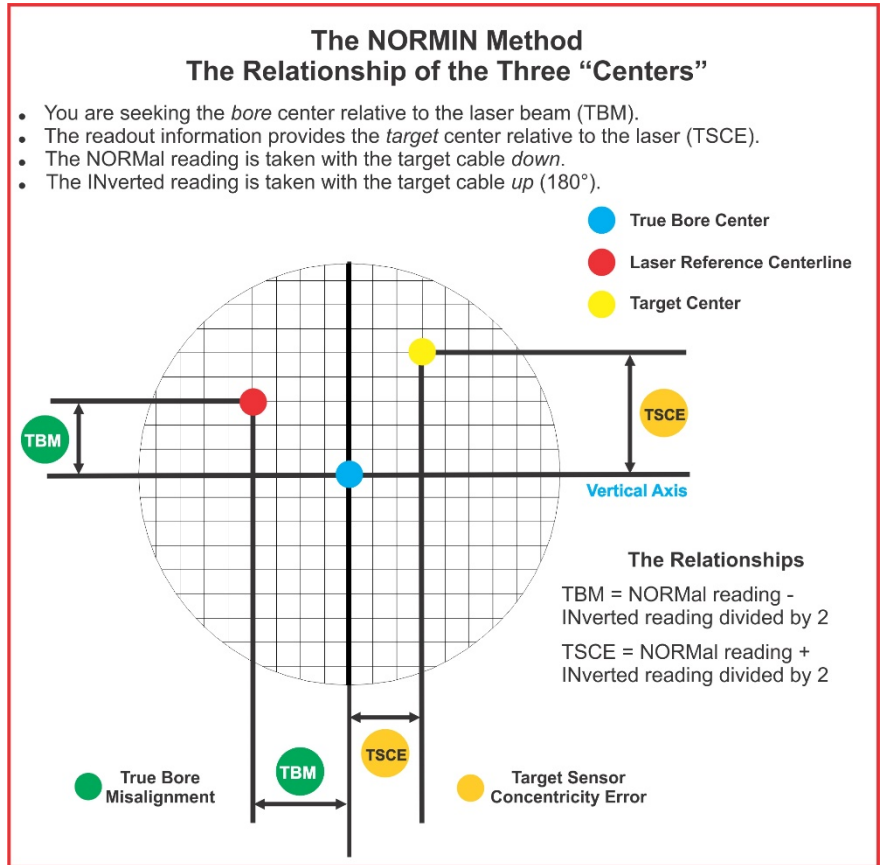

Figure 17 -- Three centers of bore alignment

The readout always shows the displacement between the Target Center and the Laser Beam Center. When the Target Center is not on the True Bore Center, the numbers and the signs on the readout will change when the target is rotated because the Target Center is moved to a different location in relationship to the laser beam.

Figure 9 represents the target in the NORMal position, with the cable *down*. If each square represents .001 in., the Target Center is .002 in. higher than the Laser Beam Center (+.002 in.) and is .007 in. to the right of the Laser Beam Center (+.007 in.).

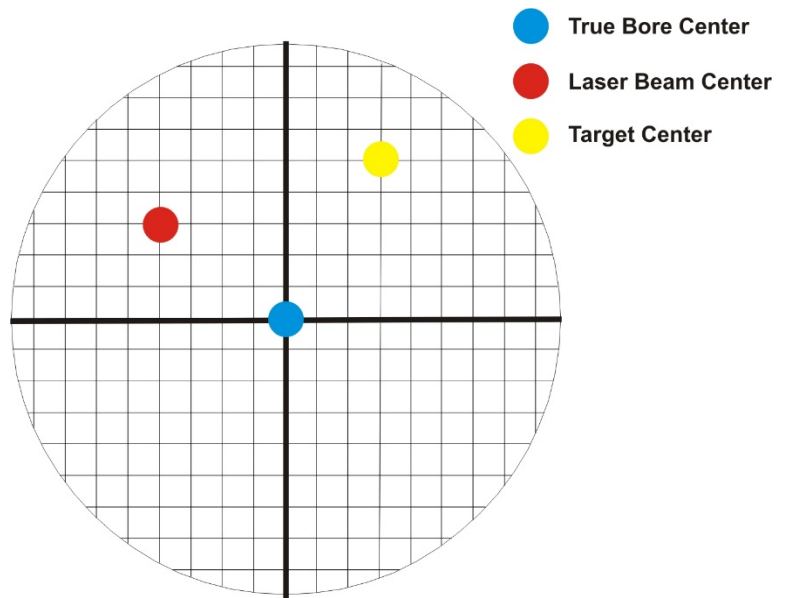

Figure 18 – Target in the NORMal position

Figure 10 represents the target in the INverted position, with the cable *up*. When the target is rotated, the *signs* on the readout are also rotated. Therefore, although the Target Center appears to be to the right of and lower than the Laser Beam Center in Figure 10, the vertical readings are positive, and the horizontal readings are negative. When the vertical TCE is calculated, (NORMal+INverted divided by 2) the Target Center is .004 in. higher and .003 in. to the right of the True Bore Center in the NORMal position.

The table below shows the calculation of the vertical and horizontal TSCE values.

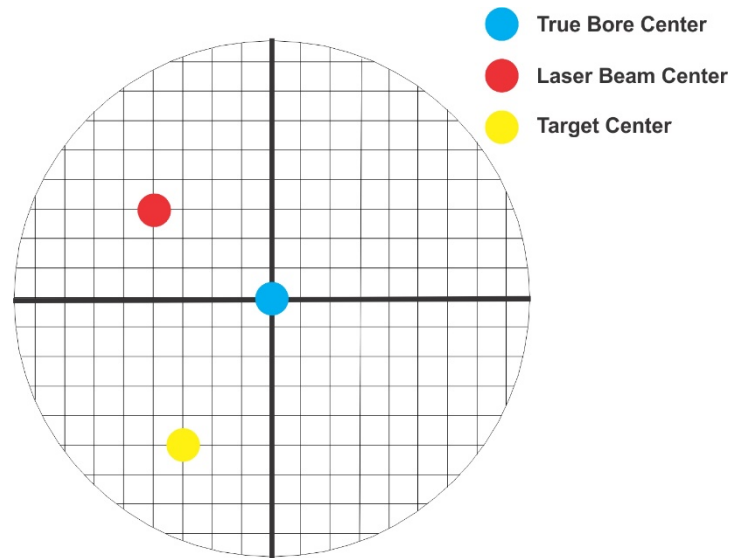

Figure 19 – Target in the INverted position

NORMal Vertical Reading	+.002 in.	NORMal Horizontal Reading	+.007 in.
INverted Vertical Reading	+.008 in.	INverted Horizontal Reading	-.001 in.
Total	+.010 in.	Total	+.006 in.
Divide by 2 = <b>Vertical TSCE</b>	<b>+.005 in.</b>	Divide by 2 = <b>Horizontal TSCE</b>	<b>+.003 in.</b>

If you place the Laser Beam Center exactly on the True Bore Center with the target in the NORMal position, the readings will show Vertical +.005 in. and Horizontal +.003 in.

# Appendix B – Configuring the R-1307-2.4XBE Readout

## Model R-1307 Readouts – Control Panel

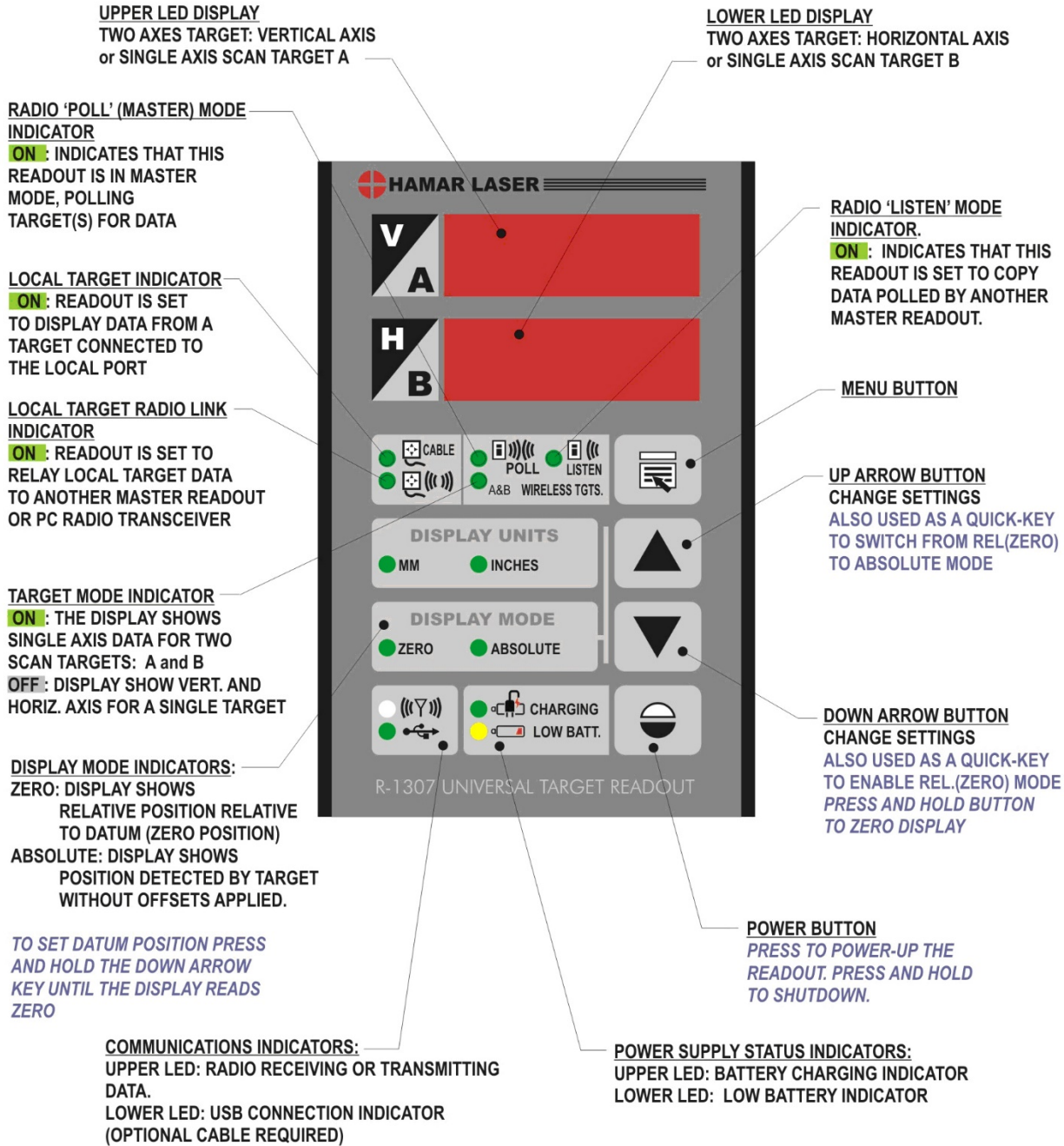

## Configuring the R-1307 Readout for a Cabled (Local) Target

**Note:** Shut off power to the readout before connecting or disconnecting a target from the local port.

- 1. Connect the cabled target to the local port of the readout**
  - 2. Press and hold the MENU button for approximately 2 seconds to enter configuration mode.**
  - 3. Set the Measurement Units**  
Press the MENU button until the upper display shows  $u n i t s$ . Use the UP and DOWN arrow keys to select either  $i n c h$  for inches or  $m m$  for millimeters.
  - 4. Set the Dampening Level**  
Press the MENU button until the upper display shows  $A v e r a g e$ . Use the UP and DOWN arrow keys to set the number of averages. Adjust this value as required to suit the application. The default for this application is 8. For long distance shots, use 16 or 32.
  - 5. Set the Readout Function to Local Target**  
Press the MENU button until the upper display shows  $F u n c t i o n$ . Use the UP and DOWN arrow keys to select  $F u n c t i o n = L O C A L$ .
  - 6. Select the PSD descriptor applicable to your target**  
Press the MENU button until the upper display shows  $T G T = n n$ , where  $n n$  designates the target calibration factor number. There is one calibration record for each target purchased. The R-1307 can store up to 9 records. Each calibration record in the R-1307 has the following target types:
    - TGT=0 (for HLI use only. Do not use )
    - TGT = nn, P.10.10 (10x10 mm sensor- pulsed beam mode)
    - TGT = nn, F.10.10 (10x10 mm sensor- fixed beam mode)
    - TGT = nn, P.4.4 (4x4 mm sensor- pulsed beam mode)
    - TGT = nn, F.4.4 (4x4 mm sensor- fixed beam mode)
    - TGT = nn, P.20.20 (20x20 mm sensor- pulsed beam mode)
    - TGT = nn, F.20.20 (20x20 mm sensor- fixed beam mode)
    - TGT = nn, P.40.40 (40x40 mm sensor- pulsed beam mode)
    - TGT = nn, F.40.40 (40x40 mm sensor- fixed beam mode)nn= R-1037 Readout number and matching target number  
  
Press the UP or DOWN arrow to select the correct target number, which will change the second window. For example,  $T G T = 0 2 F _ { 1 0 } _ { 1 0 }$  or  $T G T = 0 2 P _ { 1 0 } _ { 1 0 }$  for R-1307 #2. The PSD sensor size and type is fixed to the target calibration record.
- Warning: Targets are matched to specific calibration records in the R-1307 Readouts. For example, Target #1 must be connected to Calibration Record #1 in the R-1307 or the calibration is void. However, each R-1307 can have up to 9 target records, so up to 9 different target calibration records can be stored in each R-1307. When there are multiple calibration records, the record ID must match the target ID, so if you have Target #1, you should select TGT=01 to select the matching calibration factors.**
- 7. To exit configuration mode, press and hold the MENU button for approximately three seconds until the display returns to normal mode.**  
The R-1307 will also return to normal mode automatically after approximately four seconds of inactivity.

## Configuring the R-1307 Readout for the A-1519-2.4XBE-2X Wireless Target in Dual-Axis Mode

1. Press and hold the **Menu** button until the menu displays.
2. Press and release the **Menu** button until **ID** displays in both the V and H Display windows.
3. Use the up or down arrow keys to set the **Vertical ID** to 01.
4. Press the **Menu** button again and use the up or down arrow keys to set the **Horizontal ID** to 01.
5. Press the **Menu** button again and use the up or down arrow keys to set the **Channel** to **CH=1**
6. **Note:** *Ensure that the Target's System ID dial on the side of the target is set to 1.*



7. Press the **Menu** button until **Func** displays in the Vertical Display window. Use the up or down arrow keys until **POLL** displays in the Horizontal Display window. After a few seconds the R-1307 readout will start polling for the target. When the laser beam is on the target, readings display in the Vertical and Horizontal Display windows.
8. Press and hold the **Up** arrow key to zero the readout.
9. Take measurements in each bore as described in *Measuring Bores with the A-1511 Wand Bore Target and the R-1307 Readout* beginning on Page 40.  
**Note:** *When using the Wand Bore Fixture with the R-1307 Readout, adjust the support leg until the horizontal readings are less than .030 in. (.73 mm).*

## Appendix C – Care and Cleaning of Target Optics

---

The proper care and cleaning of optical windows and/or lenses of Hamar Laser's position-sensing devices (targets) assures optimum performance. Contaminants on an optical surface increase scatter, absorb laser energy, and eventually degrade the accuracy of the position-sensing devices. Because cleaning any precision optic risks damaging the surface, optics should only be cleaned when absolutely necessary. When cleaning is required, we recommend the following supplies and procedures.

### Required Supplies

- **Optics Cleaning Tissue:** Soft, absorbent, lint-free lens tissue
- **Swabs:** Cotton swabs with wooden handles or polyester swabs with polypropylene handles
- **Dust Blower:** Filtered dry nitrogen blown through an antistatic nozzle is best. Canned dusters, such as Dust-Off, will also work.
- **Mild Soap solution:** Neutral soap, 1 percent in distilled water. Avoid scented, alkali, or colored soap such as liquid dishwashing detergents or hand soap. Ten drops of green soap (available at a pharmacies and optical cleaning suppliers) per 100 cc of distilled water is an acceptable alternative.
- **Isopropyl Alcohol:** Spectroscopic grade. Over-the-counter alcohol contains too much water and may have impurities.
- **Acetone:** Spectroscopic grade. Do not use over-the-counter Acetone, such as the type intended for nail polish removal.

**NOTE:** *When cleaning precision optics, even with the best quality optical cleaning tissue, use gentle pressure to avoid scratching the surface or damaging the optical coating(s). Always wipe using a figure-eight motion in one direction (begin at the top and work toward the bottom in a figure-eight motion).*

*Use only moistened (not soaked) optical cleaning tissue, swabs and Spectroscopic grade Acetone and Isopropyl Alcohol. Never spray any type of liquid directly on the device or submerge any part of the device.*

### Removing Dust

Dust can bind to optics by static electricity. Blowing only removes some of the dirt. The remainder can be collected by using wet alcohol and Acetone swabs wrapped with optical lens tissue. Acetone dries rapidly and helps to eliminate streaks.

1. Blow off dust.
2. If any dust remains, twist lens tissue around a cotton swab moistened in alcohol and repeat as necessary.
3. Repeat using Acetone.

### Cleaning Heavy Contamination

Fingerprints, oil, or water spots should be cleaned immediately. Skin acids attack coatings and glass and can leave permanent stains. Cleaning with solvents alone tends to redistribute grime.

1. Blow off dust.
2. Using a soap-saturated lens tissue around a swab, wipe the optic gently. Repeat as necessary.
3. Repeat using a distilled water-saturated lens tissue wrapped around a swab.
4. Repeat using an alcohol-saturated lens tissue wrapped around a swab.
5. Repeat using an acetone-saturated lens tissue wrapped around a swab.